

Operating instructions



aroSTOR

VWL B 200/5 UK

VWL B 270/5 UK

GB, IE

Publisher/manufacturer

Vaillant GmbH

Berghauser Str. 40 | D-42859 Remscheid
Tel. +492191 18 0 | Fax +492191 18 2810
info@vaillant.de | www.vaillant.de



Contents

Contents

1	Safety	4	3.5	Information on the data plate	9
1.1	Intended use	4	3.6	CE marking	10
1.2	Danger caused by improper operation	4	3.7	Hot Water Association	10
1.3	Risk of death caused by escaping refrigerant	4	4	Function	10
1.4	Risk of death due to changes to the product or the product environment	5	4.1	Operating concept	10
1.5	Risk of burns caused by touching hot surfaces	5	4.2	Switching on the product	10
1.6	Risk of being scalded by hot drinking water	5	4.3	Setting the language	11
1.7	Preventing the risk of injury from freezing as a result of touching refrigerant	5	4.4	Setting the time	11
1.8	Risk of injury and material damage due to maintenance and repairs carried out incorrectly or not carried out at all	6	4.5	Domestic hot water temperature setting	11
1.9	Risk of damage from corrosion caused by unsuitable room air	6	4.6	Additional domestic hot water temperature setting when a photovoltaic installation is connected	11
1.10	Dangers of modifying product surroundings	6	4.7	Programming operating times	12
1.11	Frost damage due to insufficient room temperature	6	4.8	Setting the holiday mode	13
1.12	Avoid environmental damage caused by escaping refrigerant	7	4.9	Setting the boost mode	13
2	Notes on the documentation	8	4.10	Setting limp home mode	13
2.1	Observing other applicable documents	8	4.11	Activating the anti-legionella function	13
2.2	Storing documents	8	4.12	Frost protection function	13
2.3	Validity of the instructions	8	5	Troubleshooting	14
3	Product description	8	5.1	Detecting and rectifying faults	14
3.1	Product design	8	6	Maintenance and care	14
3.2	Overview of the control elements	8	6.1	Maintenance	14
3.3	Displayed symbols	9	6.2	Caring for the product	14
3.4	Type designation and serial number	9	6.3	Checking the condensate discharge pipe and tundish	14
			7	Decommissioning	14
			7.1	Temporarily decommissioning the product	14
			7.2	Permanently decommissioning the product	14
			8	Recycling and disposal	14
			8.1	Arranging disposal of refrigerant	15
			9	Guarantee and customer service	15
			9.1	Guarantee	15
			Appendix	16	
			A	Troubleshooting	16

Contents

B	Optimising energy consumption	17
B.1	Using a low tariff and a control cable connection	17
B.2	Using a low tariff without a control cable connection	18
B.3	Operating with a fixed electricity tariff	19
C	End user level – overview	20

1 Safety

1 Safety

1.1 Intended use

There is a risk of injury or death to the user or others, or of damage to the product and other property in the event of improper use or use for which it is not intended.

The product is intended for hot water generation.

Intended use includes the following:

- observance of the operating instructions included for the product and any other installation components
- compliance with all inspection and maintenance conditions listed in the instructions.

This product can be used by children aged from 8 years and above and persons with reduced physical, sensory or mental capabilities or lack of experience and knowledge if they have been given supervision or instruction concerning use of the product in a safe way and understand the hazards involved. Children must not play with the product. Cleaning and user maintenance work must not be carried out by children unless they are supervised.

Any other use that is not specified in these instructions, or use beyond that specified in this document, shall be considered improper use. Any direct commercial or industrial use is also deemed to be improper.

Caution.

Improper use of any kind is prohibited.

1.2 Danger caused by improper operation

Improper operation may present a danger to you and others, and cause material damage.

- ▶ Carefully read the enclosed instructions and all other applicable documents, particularly the "Safety" section and the warnings.
- ▶ Only carry out the activities for which instructions are provided in these operating instructions.

1.3 Risk of death caused by escaping refrigerant

The product contains R 290 refrigerant.

R 290 is an inflammable refrigerant.

When refrigerant escapes, there is a risk of explosion.



- ▶ If possible, open doors and windows fully and ensure adequate ventilation.
- ▶ Do not use naked flames (e.g. lighters, matches).
- ▶ Do not smoke.
- ▶ Do not use any electrical switches, mains plugs, doorbells, telephones or other communication systems in the building.
- ▶ Leave the building immediately and ensure that others do not enter the building.

1.4 Risk of death due to changes to the product or the product environment

- ▶ Never remove, bridge or block the safety devices.
- ▶ Do not tamper with any of the safety devices.
- ▶ Do not damage or remove any tamper-proof seals on components.
- ▶ Do not make any changes:
 - The product itself
 - The water and electricity supply lines
 - to the expansion relief valve
 - to the drain pipework
 - to constructional conditions that may affect the operational reliability of the product

1.5 Risk of burns caused by touching hot surfaces

The outgoing lines and hydraulic connections are hot during operation.

- ▶ Do not touch any hydraulic connections.
- ▶ Do not touch any air inlets or outlets.

1.6 Risk of being scalded by hot drinking water

There is a risk of scalding at the hot water draw-off points if the hot water temperatures are greater than 60 °C. Young children and elderly persons are particularly at risk, even at lower temperatures.

- ▶ Select the temperature so that nobody is at risk.

1.7 Preventing the risk of injury from freezing as a result of touching refrigerant

The product is delivered with an operational filling of R 290 refrigerant. This is a chlorine-free refrigerant which does not affect the Earth's ozone layer. Escaping refrigerant may cause freezing if the exit point is touched.

- ▶ If refrigerant escapes, do not touch any components of the product.



1 Safety

- ▶ Do not inhale any steam or gases that escape from the refrigerant circuit as a result of leaks.
- ▶ Avoid skin or eye contact with the refrigerant.
- ▶ In the event of skin or eye contact with the refrigerant, seek medical advice.

1.8 Risk of injury and material damage due to maintenance and repairs carried out incorrectly or not carried out at all

- ▶ Never attempt to carry out maintenance work or repairs on your product yourself.
- ▶ Faults and damage should be immediately rectified by a competent person.
- ▶ Adhere to the maintenance intervals specified.

1.9 Risk of damage from corrosion caused by unsuitable room air

Sprays, solvents, chlorinated cleaning agents, paint, adhesives, ammonia compounds, dust or similar substances may lead to corrosion on the product.

- ▶ Ensure that the air supply is always free of fluorine, chlorine, sulphur, dust, etc.

- ▶ Ensure that no chemical substances are stored at the installation site.

1.10 Dangers of modifying product surroundings

Some types of installation and conversion work in your home can impair the way your product operates.

- ▶ Consult your installer before undertaking the work in question.

1.11 Frost damage due to insufficient room temperature

If the room temperature is set too low in individual rooms, it cannot be ruled out that sections of the heating installation might be damaged by frost.

The product may release cold air into the room. This means the room temperature can fall below 0 °C.

- ▶ If you are going to be away while the outside temperature is low, ensure that the heating installation remains in operation and that the rooms are sufficiently heated.
- ▶ You must observe the frost protection instructions.



1.12 Avoid environmental damage caused by escaping refrigerant

The product contains R 290 refrigerant. The refrigerant must not be allowed to escape into the atmosphere.

Before the product is disposed of, the refrigerant that is contained in it must be completely drained into a suitable vessel so that it can then be recycled or disposed of in accordance with regulations.

- ▶ Ensure that only officially certified competent persons with appropriate protective equipment carry out maintenance work on the refrigerant circuit or access it.
- ▶ Arrange for the refrigerant contained in the product to be recycled or disposed of by certified competent persons in accordance with regulations.



2 Notes on the documentation

2 Notes on the documentation

2.1 Observing other applicable documents

- ▶ You must observe all operating instructions enclosed with the system components.

2.2 Storing documents

- ▶ Keep this manual and all other applicable documents safe for future use.

2.3 Validity of the instructions

Validity: Great Britain

These instructions apply only to:

Unit – article number

aroSTOR VWL B 200/5 UK	0010024440
aroSTOR VWL B 270/5 UK	0010028218

3 Product description

The product operates at air temperatures between -7 °C and +35 °C. Outside of this temperature range, domestic hot water generation is only possible when using an additional power infeed (heating coil).

3.1 Product design

Validity: Great Britain

Validity: aroSTOR VWL B 200/5,
aroSTOR VWL B 270/5

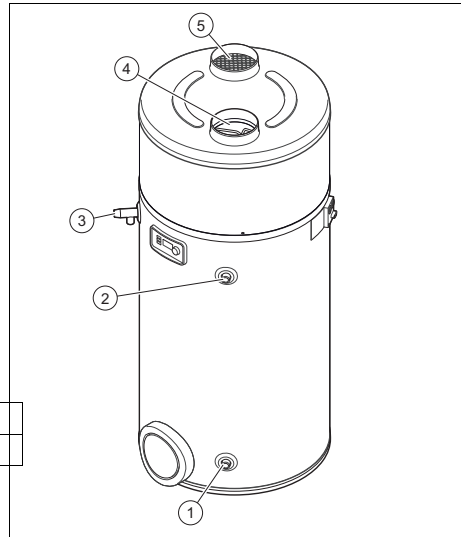





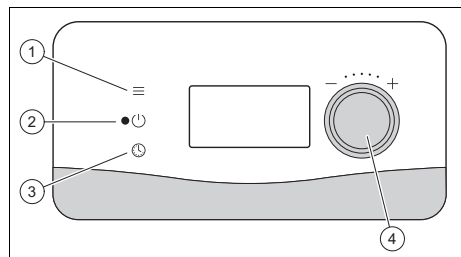







- | | |
|-----------------------------|---|
| 1 Cold water inlet | 3 Temperature and pressure expansion relief valve |
| 2 Domestic hot water outlet | 4 Air supply |
| | 5 Air removal |

3.2 Overview of the control elements



- | | |
|---------------------|-------------------------------|
| 1 Menu button | 3 Button for setting the time |
| 2 On and off button | 4 Rotary knob |

3.3 Displayed symbols

Sym- bol	Meaning
	Compressor in operation
	Fan in operation
	Defrosting function active
	Electric back-up heater in operation
	Domestic hot water demand
	ECO mode active
	Frost protection mode active
	Holiday mode active
	Photovoltaic mode active
	Display locked
	Comfort mode active
	Programming mode active

3.4 Type designation and serial number

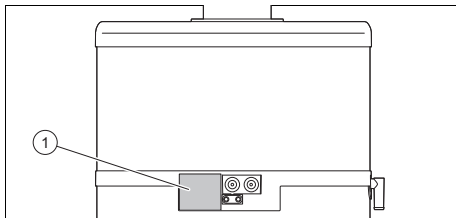







The type designation and serial number are on the data plate (1).

3.5 Information on the data plate



Validity: Great Britain
OR aroSTOR VWL B 270/5

The data plate is mounted on the right-hand side of the product at the factory.

Information on the data plate	Meaning
aroSTOR VWL	Type designation
B	Cylinder type
270	Cylinder volume

Information on the data plate	Meaning
/5	Unit version
UK	Country-specific feature
COP	Coefficient of performance – heating
230 V (single-phase) ~ 50 Hz	Voltage and frequency of the product's power supply
P max	Max. power consumption
I max	Max amperage of the power supply circuit
IP...	IP rating/protection class
	Total weight of the empty product
	Nominal capacity of the cylinder Max. pressure in the domestic hot water circuit Max. temperature in the domestic hot water circuit
 P	The refrigeration circuit Refrigerant type, fill quantity, permissible rated excess pressure Nominal heat output of the refrigeration circuit
	Max. air flow in the heat pump
P	Nominal heat output of the electric back-up heater
	Barcode with serial number, The 7th to 16th digits of the serial number form the article number
	Disposal of the packaging

4 Function

Information on the data plate	Meaning
	The cylinder contains a combustible product
	See instructions

3.6 CE marking



The CE marking shows that the products comply with the basic requirements of the applicable directives as stated on the data plate.

The declaration of conformity can be viewed at the manufacturer's site.

3.7 Hot Water Association

Vaillant is a full member of the Hot Water Association and promotes the scheme in association with its cylinder range. Details are available on the web site www.vaillant.co.uk



4 Function

4.1 Operating concept

You can use the three buttons to control the product.

- You can press the menu button to access the main menu.
- You can press the rotary knob to select the menu items and confirm set values. You can press the rotary knob to set these values.

- You can use the clock button to set the time.

The display switches off 180 seconds after the last operation.

4.2 Switching on the product

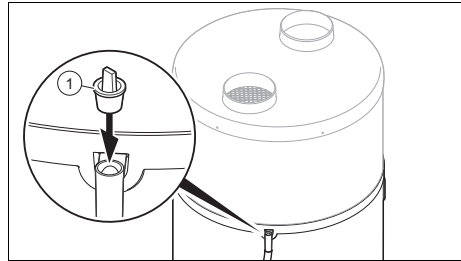

1. Before starting up the product, ensure that the plugs **(1)** have been removed from the condensate discharge connection.
2. Ensure that the stopcock upstream of the safety group at the cold water inlet is open.
3. Before switching on the power supply, ensure that the domestic hot water cylinder is full.
4. Ensure that the product has been connected to the power supply.
5. Press the product's on/off button.
 - < The display switches on.
 - < A green LED lights up on the display.
 - < The background lighting on the display flashes and prompts you to set the language.
 - Turn the rotary knob to set the language. Press the rotary knob to confirm the selection.
 - < The unit only offers you the language selection when it is switched on for the first time. However, you have the opportunity to change the language setting. To do this, follow the instructions in the section on setting the language. (→ Page 11)
 - < The heat pump only starts when the cold water temperature is be-

low the set water temperature and when, according to the operating programme, the switch-on time corresponds to the heat-up time and heating is permitted by the electricity tariff.

- ◁ When the heat pump is running, there is an air flow at the air inlet and outlet.



Note

After the initial start-up, depending on the air intake temperature and cold water temperature, the heat pump requires 5 to 12 hours to reach a temperature of 55 °C.

4.3 Setting the language

- ▶ If you want to change the current setting, press the menu button.
- ▶ Turn the rotary knob until the display shows the language setting.
- ▶ Press the rotary knob.
- ▶ Select the required language using the rotary knob.
- ▶ Press the rotary knob to confirm.
- ▶ Press the menu button to return to the original display.

4.4 Setting the time

- ▶ Press the clock button.
- ▶ Press the rotary knob to confirm.
- ▶ Turn the rotary knob to set the day.
- ▶ Press the rotary knob to confirm.
- ▶ Turn the rotary knob to set the month.
- ▶ Press the rotary knob to confirm.
- ▶ Turn the rotary knob to set the year.
- ▶ Press the rotary knob to confirm.
- ▶ Turn the rotary knob to set the hour.
- ▶ Press the rotary knob to confirm.
- ▶ Turn the rotary knob to set the minutes.
- ▶ Press the rotary knob to confirm.
- ▶ Press the menu button to return to the original display.

4.5 Domestic hot water temperature setting

1. Press the menu button.
2. Turn the rotary knob until the **TEMP. SETT.** menu appears in the display.
3. Press the rotary knob.
4. Turn the rotary knob to set the required domestic hot water temperature (**TARGET**).
5. Press the rotary knob to confirm.
6. Press the menu button to return to the original display.

4.6 Additional domestic hot water temperature setting when a photovoltaic installation is connected



Note

If this function is activated in the installer level, the settings can be made.

1. Press the menu button.
2. Turn the rotary knob until the **T°PV ECO** menu appears in the display.
3. Press the rotary knob.
4. Turn the rotary knob to set the desired domestic hot water temperature, which is generated using the electrical energy from the photovoltaic installation.
 - ◁ **T°PV ECO**: The heat pump heats the water in the domestic hot water cylinder up to a temperature above the normal domestic hot water temperature.
 - ◁ **T°PV MAX**: The heat pump and immersion heater heat the water in the domestic hot water cylinder to a temperature above parameter **T°PV ECO**.

4 Function



Note

When the photovoltaic installation generates electricity, the domestic hot water temperature setting is automatically adjusted.

5. Press the rotary knob to confirm.
6. Press the menu button to return to the original display.

4.7 Programming operating times

You can optimise the product's energy consumption (kWh) by programming the operating hours. Consider the following points when creating such a programme:

- Electricity tariff tiers (low-/high-tariff periods)
- Temperature of the drawn-in air (the product is more efficient during the warmest parts of the day)
- Check that the product is actuated by a low-tariff cable

4.7.1 Programming the operating times for the first day of the week

- ▶ Hold down the clock button for three seconds.
- ▶ Select the day using the rotary knob.
- ▶ Press the rotary knob.
- ▶ Press the rotary knob to create a new programme for this day.
- ▶ Turn the rotary knob to set the end of the first operating time.
- ▶ Press the rotary knob.
- ▶ Turn the rotary knob to set the comfort level for the first operating time.
 - ◁ **F-P**: Defrosting – the product prevents freezing (water temperature of at least +5 °C).
 - ◁ **ECO**: Eco mode – the heat pump heats the domestic hot water cylinder to the set target temperature.
 - ◁ **COmF**: Comfort mode – the heat pump and the immersion heater heat

the domestic hot water cylinder to the set target temperature.

- ▶ Press the rotary knob.
- ▶ Turn the rotary knob to set the end of the second operating time.
- ▶ Press the rotary knob.
- ▶ Repeat these steps to set additional operating times (up to seven per day).
- ▶ Turn the rotary knob to set the end of the last operating time to its start time.
 - ◁ The end of the operating time is automatically displayed as 24:00.
- ▶ Press the rotary knob.
- ▶ Press the menu button to return to the original display.



Note

Connecting a photovoltaic installation can cause the product to go into operation outside of programmed time periods. The relevant settings are made by the competent person. If necessary, discuss the setting with your competent person.

4.7.2 Programming the operating times for additional days of the week

- ▶ Hold down the clock button for three seconds.
- ▶ Select the day using the rotary knob.
- ▶ Press the rotary knob.
- ▶ Turn the rotary knob to create a programme for this day.
- ▶ You can copy the programme from the previous day.
- ▶ If you want to copy the programme for a different day, select **COPY PROG..**
- ▶ You can use **MODIFY PR.** to change a copied programme.
- ▶ You can use **SEE PROG.** to check an existing programme.
- ▶ Press the menu button to return to the original display.

4.8 Setting the holiday mode

This mode puts the product into standby operation in which the frost protection function remains active. This is a programmable mode. A duration between 1 and 99 days can be programmed. When you confirm the number of days (1 day = 24-hour time period), the mode will be activated.

This mode temporarily suspends the set time programming.

The mode ends automatically once the set number of days has expired. Throughout the holiday, the display shows **HOLI.RETUR.** (return from holiday) and the number of days remaining.

- ▶ Press the menu button.
- ▶ Turn the rotary knob until the **HOLI DAYS** menu appears in the display.
- ▶ Press the rotary knob.
- ▶ Turn the rotary knob to set the required number of days' holiday.
- ▶ Press the rotary knob.
- ▶ Press the menu button to return to the original display.
- ▶ If you return from holiday earlier than planned, repeat the steps described above and set the number of days' holiday to 0.

4.9 Setting the boost mode

This mode enables temporary simultaneous operation of the back-up heater (immersion heater) and the heat pump, in order to heat up the domestic hot water more quickly. The symbol (back-up heater in operation) flashes. If the set target temperature in the domestic hot water cylinder is reached, the mode is automatically deactivated.

This mode is automatically deactivated at most 24 hours after it was activated.

This mode temporarily suspends the set time programming.

- ▶ Press the menu button.

- ▶ Turn the rotary knob until the **BOOST** menu appears in the display.
- ▶ Press the rotary knob.
- ▶ Turn the rotary knob to activate the **BOOST** mode.
- ▶ Press the rotary knob.
- ▶ Press the menu button to return to the original display.

4.10 Setting limp home mode

This mode enables a limp home mode for cases where use of the heat pump is prevented (air pipes not yet connected, dust-intensive work in the product's vicinity...). In this mode, energy savings cannot be achieved by using the heat pump. It should therefore be used in exceptional circumstances and for a limited time period only.

- ▶ Press the menu button.
- ▶ Turn the rotary knob until the **ELEC. MODE** menu appears in the display.
- ▶ Press the rotary knob.
- ▶ Turn the rotary knob to activate the limp home mode.
- ▶ Press the rotary knob.
- ▶ Press the menu button to return to the original display.

4.11 Activating the anti-legionella function

The product has an anti-legionella function. In doing so, the water in the domestic hot water cylinder to a temperature between 60 °C and 70 °C.

Consult your competent person to activate or deactivate the anti-legionella function.

4.12 Frost protection function



Note

The product is protected by the frost protection function. The hot and cold water circuit is not protected by the product.

5 Troubleshooting

5 Troubleshooting

5.1 Detecting and rectifying faults

This section shows all of the fault messages that can be rectified without seeking help from the competent person in order to start up the product again.

Troubleshooting (→ Page 16)

- ▶ Ensure that the product generally works without any problems and that no fault messages or alarms are displayed.
- ▶ If the product still does not function after the fault has been rectified, contact your competent person.

6 Maintenance and care

6.1 Maintenance

An annual inspection and maintenance of the product carried out by a competent person is a prerequisite for ensuring that the product is permanently ready and safe for operation, reliable, and has a long working life.

6.2 Caring for the product

- ▶ Clean the casing with a damp cloth and a little solvent-free soap.
- ▶ Do not use sprays, scouring agents, detergents, solvents or cleaning agents that contain chlorine.

6.3 Checking the condensate discharge pipe and tundish

The condensate discharge pipe and tundish must always be penetrable.

- ▶ Regularly check the condensate discharge pipe and tundish for faults and, particularly, for blockages.

You must not be able to see or feel any obstructions in the condensate discharge pipe and tundish.

- ▶ If you notice a fault, have it eliminated by a competent person.

7 Decommissioning

7.1 Temporarily decommissioning the product

- ▶ If, during long periods of absence, the power supply to the dwelling and to the product is interrupted, have the product drained by your competent person or have it sufficiently protected against frost.

7.2 Permanently decommissioning the product

- ▶ Have a competent person permanently decommission the product.

8 Recycling and disposal

- ▶ The competent person who installed your product is responsible for the disposal of the packaging.



■ If the product is labelled with this mark:

- ▶ In this case, do not dispose of the product with the household waste.
- ▶ Instead, hand in the product to a collection centre for waste electrical or electronic equipment.



■ If the product contains batteries that are labelled with this mark, these batteries may contain substances that are hazardous to human health and the environment.

- ▶ In this case, dispose of the batteries at a collection point for batteries.

Guarantee and customer service 9

8.1 Arranging disposal of refrigerant

The product contains R 290 refrigerant.

- ▶ Refrigerant must only be disposed of by qualified competent persons.
- ▶ Observe the general safety information.

9 Guarantee and customer service

9.1 Guarantee

Validity: Great Britain, Vaillant

Vaillant provides a full parts and labour guarantee for this appliance for the duration as shown on the enclosed registration card which must be fully completed and returned within 30 days of installation. All appliances must be installed by a suitably competent person fully conversant and in accordance with all current regulations applicable to the appliance type installation. In the case of gas appliances the Gas Safety (Installation and Use) Regulations 1998, and the manufacturer's instructions. In the UK competent persons approved at the time by the Health and Safety Executive undertake the work in compliance with safe and satisfactory standards. Installers should also be fully conversant with and competent with all necessary electrical and building regulations that may apply to the installation.

In addition all unvented domestic hot water cylinders must be installed by a competent person to the prevailing building regulations at the time of installation (G3). All appliances shall be fully commissioned in accordance with our installation manual and Benchmark commissioning check list (this will be included within the installation manual). These must be signed and given to the user for safe keeping during the hand over process. Installers should also at this time advise the user of the an-

nual servicing requirements and advise of appropriate service agreement.

Terms and conditions do apply to the guarantee, details of which can be found on the registration card included with this appliance. In order to qualify for guarantee after one year the appliance must be serviced in accordance with our installation manual servicing instructions. The benchmark service history should be completed. Note - all costs associated with this service are excluded from this guarantee.

Failure to install and commission this appliance in compliance with the manufacturer's instructions will invalidate the guarantee (this does not affect the customer's statutory rights).

Appendix

Appendix

A Troubleshooting

Fault	Cause	Solution
The product no longer works.	The power supply is interrupted.	Ensure that there has not been a power cut and that the product is correctly connected to the power supply. When the power supply is re-established, the product automatically starts up. If a fault is still present, contact your competent person.
	The set target temperature of the water is reached.	Check the domestic hot water temperature.
	The product is switched off.	Check whether the product is switched on and the green LED is lit up.
	The product is in holiday mode.	Switch off holiday mode.
	The air inlet temperature is below -7 °C or above +35 °C.	Ensure that the domestic hot water cylinder is heated using the back-up energy sources (immersion heater). If the air inlet temperature is once again between -7 °C or and +35 °C, the heat pump restarts.
	Time programming conflicts with the high-tariff load relief.	Check the time programming.
	A programmed operating time is preventing operation (ECO symbol is lit up).	Check the set operating times.
There is a hot water shortage.	The domestic hot water volume, which was used within a short space of time, is larger than the volumetric capacity of the domestic hot water cylinder.	Wait until the domestic hot water cylinder is supplied with sufficient hot water again.
	The programmed operating time for the heat pump is too short (at least 12 hours in a 24 hour period).	Set the operating time so that the domestic hot water cylinder is charged for at least 12 hours in a 24 hour period.
	The setting for the set target temperature is too low	Increase the set target temperature.
	Time programming conflicts with the high-tariff load relief.	Check the time programming.

Fault	Cause	Solution
The condensate does not drain off (water underneath the product).	The condensate discharge hose is partly or completely blocked	Check the condensate discharge hose.
	There is a kink in the condensate discharge hose and this is forming a trough.	
	The condensate discharge hose is not installed.	Consult your competent person.
The electric back-up heater is not working.	The ESC contact or a programmed operating time is preventing operation (ECO symbol is lit up).	Check the time programming and consult your competent person.
	The safety cut-out for the electric back-up heater has been tripped as a result of overheating (> 87 °C).	Consult your competent person.
Other faults		Consult your competent person.

B Optimising energy consumption

B.1 Using a low tariff and a control cable connection

Settings made by the end user			
Setting/function	Particularly economical	Average	For increased comfort
Target temperature	45 °C	55 °C	65 °C
Time programming	None	None	None
Holiday mode	For absences of more than 24 hours	For absences of more than 3 days	For absences of over a week
Boost mode	Never	Occasionally	Often
Settings made by the competent person			
Setting/function	Particularly economical	Average	Particularly expensive
Anti-legionella cycle	No	7 (weekly)	1 (daily – not required)
Minimum temperature	No	43 °C	43 °C
MAX. TIME function	No	Auto	4 hours
Load relief level for high-tariff periods (HT)	0 (Operation of the immersion heater and the heat pump prevented during high-tariff periods)	1 (Operation of the immersion heater prevented during high-tariff periods)	2 (Deactivation of the load relief circuit)
*) Exception: The air temperature lies outside the range between -7 °C and +35 °C. In this case, operation of the back-up heater is permitted.			

Appendix

Overview of the operating mode	<ul style="list-style-type: none"> – LT: Heat pump and immersion heater (where applicable) heat the domestic hot water cylinder – HT: The product runs in frost protection mode (at least +5 °C) 	<ul style="list-style-type: none"> – LT: Heat pump and immersion heater (where applicable) heat the domestic hot water cylinder – HT: Only the heat pump heats the domestic hot water cylinder * 	Heat pump and immersion heater heat the domestic hot water cylinder without any time restriction.
*) Exception: The air temperature lies outside the range between -7 °C and +35 °C. In this case, operation of the back-up heater is permitted.			

B.2 Using a low tariff without a control cable connection

Settings made by the end user			
Setting/function	Particularly economical	Average	For increased comfort
Target temperature	45 °C	55 °C	65 °C
Time programming	Low tariff (LT) → ECO High tariff (HT) → Frost protection	Low tariff (LT) → Comfort High tariff (HT) up to 12:00 → ECO High tariff (HT) after 12:00 → Frost protection	Low tariff (LT) → Comfort High tariff (HT) up to 12:00 → Comfort High tariff (HT) after 12:00 → ECO
Holiday mode	For absences of more than 24 hours	For absences of more than 3 days	For absences of over a week
Boost mode	Never	Occasionally	Often
Settings made by the competent person			
Setting/function	Particularly economical	Average	Particularly expensive
Anti-legionella cycle	No	7 (weekly)	1 (daily – not required)
Minimum temperature	No	43 °C	43 °C
MAX. TIME function	No	6 hours	4 hours
Load relief level for high-tariff periods (HT)	Invalid (factory setting to 1)	Invalid (factory setting to 1)	Invalid (factory setting to 1)
*) Exception: The air temperature lies outside the range between -7 °C and +35 °C. In this case, operation of the back-up heater is permitted.			

Overview of the operating mode	<ul style="list-style-type: none"> - LT: Only the heat pump heats the domestic hot water cylinder * - HT: The product runs in frost protection mode (at least +5 °C) 	<ul style="list-style-type: none"> - LT: Heat pump and immersion heater heat the domestic hot water cylinder - HT up to 12:00: The heat pump supplements the heating of the domestic hot water cylinder - HT after 12:00: The product runs in frost protection mode (at least +5 °C) 	<ul style="list-style-type: none"> - LT + HT up to 12:00: Heat pump and immersion heater heat the domestic hot water cylinder - HT after 12:00: Only the heat pump heats the domestic hot water cylinder *
*) Exception: The air temperature lies outside the range between -7 °C and +35 °C. In this case, operation of the back-up heater is permitted.			

B.3 Operating with a fixed electricity tariff

Settings made by the end user			
Setting/function	Particularly economical	Average	For increased comfort
Target temperature	45 °C	55 °C	65 °C
Time programming	From 23:00 to 11:00: Frost protection From 11:00 to 23:00: ECO	No programming	From 23:00 to 11:00: ECO From 11:00 to 23:00: No programming
Holiday mode	For absences of more than 24 hours	For absences of more than 3 days	For absences of over a week
Boost mode	Never	Occasionally	Often
Settings made by the competent person			
Setting/function	Particularly economical	Average	Particularly expensive
Anti-legionella cycle	No	7 (weekly)	1 (daily – not required)
Minimum temperature	No	43 °C	43 °C
MAX. TIME function	No	6 hours	4 hours
Load relief level for high-tariff periods (HT)	Invalid (factory setting to 1)	Invalid (factory setting to 1)	Invalid (factory setting to 1)
*) Exception: The air temperature lies outside the range between -7 °C and +35 °C. In this case, operation of the back-up heater is permitted.			

Appendix

Overview of the operating mode	<ul style="list-style-type: none"> – From 23:00 to 11:00: The product runs in frost protection mode (at least +5 °C) – From 11:00 to 23:00: The heat pump heats the domestic hot water cylinder with improved efficiency * 	The heat pump heats the domestic hot water cylinder *.	<ul style="list-style-type: none"> – From 23:00 to 11:00: The heat pump heats the domestic hot water cylinder * – From 11:00 to 23:00: The heat pump heats the domestic hot water cylinder with improved efficiency. The immersion heater can be switched on as required.
*) Exception: The air temperature lies outside the range between -7 °C and +35 °C. In this case, operation of the back-up heater is permitted.			

C End user level – overview

Validity: Vaillant

Setting level	Values		Unit	Increment, select, explanation	Default setting
	Min.	Max.			
TEMP. SETT. →					
TARGET TARGET WATER TEMP.	30 to 65 °C		°C	1	55
T°PV ECO	TARGET < T°PV ECO < T°PV MAX		°C	1, if the photovoltaic installation is connected	60
T°PV MAX	T°PV ECO < 65 °C		°C	1, if the photovoltaic installation is connected	65
HOLI DAYS →					
HOLI.RETUR.	0	99	Days	1	0
ELEC. MODE (VWL B 290/4) →					
ELEC. MODE				Yes, No	No
BOIL. MODE (VWL BM 290/4) →					
BOIL. MODE				Yes, No	No
BOOST →					
BOOST				Yes, No	No
BACK UP →					

Appendix

Setting level	Values		Unit	Increment, select, explanation	Default setting
	Min.	Max.			
BA CK UP				ELEC.BACKP, BOIL.BACKP	ELEC.BACKP
LAN GUAGE →					
LAN GUAGE				16 available languages	EnG
INST.MENU →					



0020285064_00

0020285064_00 ■ 28.02.2019

Supplier

Vaillant Ltd.

Nottingham Road ■ Belper 1■1 Derbyshire 1■1 DE56 1JT

Telephone 0330 100 3461

info@vaillant.co.uk ■ www.vaillant.co.uk

© These instructions, or parts thereof, are protected by copyright and may be reproduced or distributed only with the manufacturer's written consent.
Subject to technical modifications.