



# Glow-worm

The energy you need

## Operating instructions

Energy

35 Store-A (H-GB)

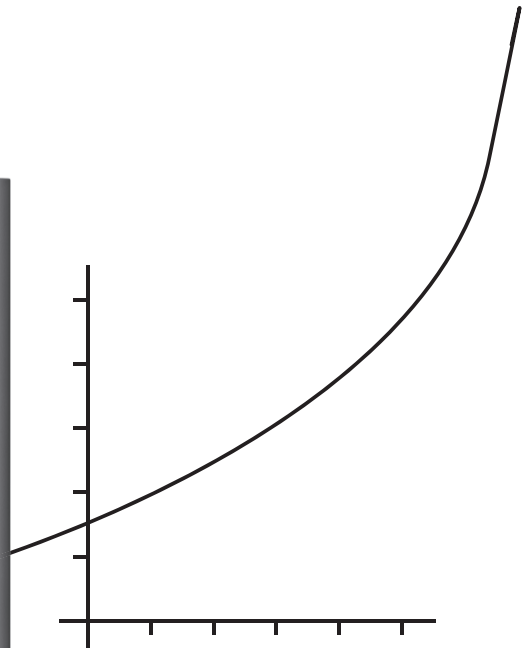

GB, IE

# Contents

<b>Contents</b>	<b>8</b>	<b>Recycling and disposal.....</b>	<b>12</b>
<b>1 Safety .....</b>	<b>3</b>	<b>9 Guarantee and customer service .....</b>	<b>12</b>
1.1 Action-related warnings .....	3	9.1 Guarantee.....	12
1.2 Intended use .....	3	9.2 Customer service.....	12
1.3 General safety information.....	4	<b>Appendix .....</b>	<b>13</b>
<b>2 Notes on the documentation .....</b>	<b>7</b>	<b>A Troubleshooting .....</b>	<b>13</b>
2.1 Observing other applicable documents .....	7		
2.2 Storing documents.....	7		
2.3 Applicability of the instructions.....	7		
<b>3 Product description .....</b>	<b>7</b>		
3.1 CE label .....	7		
3.2 Design of the product.....	7		
3.3 Overview of the operator control elements .....	7		
3.4 Description of the display.....	8		
3.5 Description of button functions .....	8		
<b>4 Operation .....</b>	<b>8</b>		
4.1 Starting up the product .....	8		
4.2 Checking the pressure in the heating installation .....	8		
4.3 Filling the heating installation.....	9		
4.4 Selecting the operating mode .....	9		
4.5 Setting the hot water temperature .....	9		
4.6 Setting the heating flow temperature .....	10		
4.7 Frost protection .....	10		
<b>5 Troubleshooting .....</b>	<b>11</b>		
5.1 Detecting and rectifying faults.....	11		
5.2 Fault codes in the display .....	11		
<b>6 Care and maintenance .....</b>	<b>11</b>		
6.1 Maintenance .....	11		
6.2 Caring for the product.....	11		
6.3 Checking the condensate drain pipework and tundish.....	11		
<b>7 Decommissioning .....</b>	<b>12</b>		
7.1 Temporarily decommissioning the product.....	12		
7.2 Permanently decommissioning the product.....	12		

## 1 Safety

### 1.1 Action-related warnings

#### Classification of action-related warnings

The action-related warnings are classified in accordance with the severity of the possible danger using the following warning signs and signal words:

#### Warning symbols and signal words



#### **Danger!**

Imminent danger to life or risk of severe personal injury



#### **Danger!**

Risk of death from electric shock



#### **Warning.**

Risk of minor personal injury



#### **Caution.**

Risk of material or environmental damage

### 1.2 Intended use

There is a risk of injury or death to the user or others, or of damage to the product and other property in the event of improper use or use for which it is not intended.

The product is intended as a heat generator for closed cent-

ral heating installations and for hot water generation.

Intended use includes the following:

- observance of the operating instructions included for the product and any other system components
- compliance with all inspection and maintenance conditions listed in the instructions.

This product can be used by children over eight years old and also by persons with limited physical, sensory or mental capabilities or insufficient experience and/or knowledge if they are supervised or have been provided with instructions on how to safely use the product, and they understand the risks resulting from using the product. Children must not play with the product. Cleaning and user maintenance work must not be carried out by children unless they are supervised.

Any other use that is not specified in these instructions, or use beyond that specified in this document shall be considered improper use. Any direct commercial or industrial use is also deemed to be improper.

#### **Caution.**

# 1 Safety

Improper use of any kind is prohibited.

## 1.3 General safety information

### 1.3.1 Installation by skilled tradesmen only

The installation, inspection, maintenance and repair of the product, as well as the gas ratio settings, must only be carried out by a competent person.

### 1.3.2 Danger caused by improper operation

Improper operation may present a danger to you and others, and cause material damage.

- ▶ Carefully read the enclosed instructions and all other applicable documents, particularly the "Safety" section and the warnings.

### 1.3.3 Risk of death from escaping gas

What to do if you smell gas in the building:

- ▶ Avoid rooms that smell of gas.
- ▶ If possible, open doors and windows fully and ensure adequate ventilation.
- ▶ Do not use naked flames (e.g. lighters, matches).
- ▶ Do not smoke.

- ▶ Do not use any electrical switches, mains plugs, door-bells, telephones or other communication systems in the building.
- ▶ If it is safe to do so, close the emergency control valve or the main isolator.
- ▶ If possible, close the gas isolator cock on the product.
- ▶ Warn other occupants in the building by yelling or banging on doors or walls.
- ▶ Leave the building immediately and ensure that others do not enter the building.
- ▶ Notify the gas supply company or National Grid Transco +44 (0) 800 111999 by telephone from outside of the building.

### 1.3.4 Risk of death due to blocked or leaking flue gas routes

What to do if you smell flue gas in the property:

- ▶ Open all accessible doors and windows fully to provide ventilation.
- ▶ Switch off the product.
- ▶ Inform a heating specialist company.

### 1.3.5 Risk of death from escaping flue gas

If you operate the product with an empty condensate siphon, flue gas may escape into the room air.

- ▶ In order to operate the product, ensure that the condensate siphon is always full.

### 1.3.6 Risk of death due to explosive and flammable materials

- ▶ Do not use or store explosive or flammable materials (e.g. petrol, paper, paint) in the installation room of the product.

### 1.3.7 Risk of death due to lack of safety devices

A lack of safety devices (e.g. expansion relief valve, expansion vessel) can lead to potentially fatal scalding and other injuries, e.g. due to explosions.

- ▶ Ask a competent person to explain how the safety devices work and where they are located.

### 1.3.8 Risk of death due to changes to the product or the product environment

- ▶ Never remove, bridge or block the safety devices.

- ▶ Do not alter the safety devices in any way.
- ▶ Do not damage or remove any seals on components.
- ▶ Do not make any changes:
  - The product itself
  - to the gas, air, water and electricity supplies
  - to the entire flue gas installation
  - to the entire condensate drain system
  - to the expansion relief valve
  - to the drain lines
  - to constructional conditions that may affect the operational reliability of the product

### 1.3.9 Risk of poisoning caused by insufficient supply of combustion air

**Conditions:** Open-flued operation

- ▶ Ensure that there is a sufficient supply of combustion air.

### 1.3.10 Risk of injury and material damage due to maintenance and repairs carried out incorrectly or not carried out at all

- ▶ Never attempt to carry out maintenance work or repairs on your product yourself.



## 1 Safety

- ▶ Faults and damage should be immediately rectified by a competent person.
- ▶ Adhere to the maintenance intervals specified.

### 1.3.11 Risk of corrosion damage due to unsuitable combustion and room air

Sprays, solvents, chlorinated cleaning agents, paint, adhesives, ammonia compounds, dust or similar substances may lead to corrosion on the product and in the flue pipe.

- ▶ Ensure that the supply of combustion air is always free of fluorine, chlorine, sulphur, dust, etc.
- ▶ Ensure that no chemical substances are stored at the installation site.

### 1.3.12 Cabinet-type casing

Enclosing the product in cabinet-type casing requires compliance with the applicable design instructions.

- ▶ Do not fit the casing on the product yourself.
- ▶ If you require cabinet-type casing for the product, consult an approved heating specialist company.



### 1.3.13 Risk of material damage caused by frost

- ▶ Ensure that the heating installation always remains in operation during freezing conditions and that all rooms are sufficiently heated.
- ▶ If you cannot ensure the operation, have a competent person drain the heating installation.

## Notes on the documentation 2

### 2 Notes on the documentation

#### 2.1 Observing other applicable documents

- ▶ You must observe all operating instructions enclosed with the system components.

#### 2.2 Storing documents

- ▶ Keep this manual and all other applicable documents safe for future use.

#### 2.3 Applicability of the instructions

These instructions apply only to:

##### Models and article numbers

	Great Britain	Ireland
Energy 35 Store-A	0010017338	0010017338

### 3 Product description

#### 3.1 CE label



The CE label shows that the products comply with the basic requirements of the applicable directives as stated on the identification plate.

The declaration of conformity can be viewed at the manufacturer's site.

#### 3.2 Design of the product

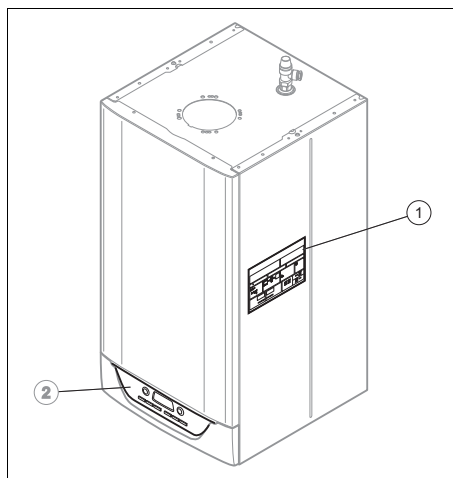

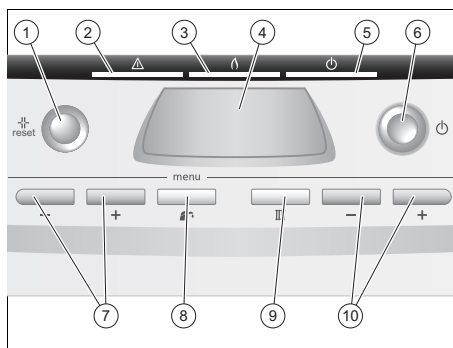

- 1 Magnetic brief operating instructions with type designation and serial number
- 2 Control elements

#### 3.3 Overview of the operator control elements

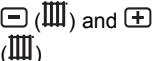

- 1 Fault clearance key
- 2 Red LED fault lamp
- 3 Orange LED lamp for burner operation
- 4 Display
- 5 Green LED lamp for product operation
- 6 On/off button
- 7 Hot water temperature setting buttons (minus) and (plus)

## 4 Operation



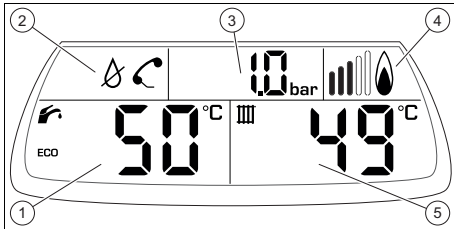

- 8 DHW mode  10 Heating flow temperature buttons 
- 9 Heating mode 

### 3.4 Description of the display



- 1 Hot water temperature  
2 Fault symbols  
3 System pressure/fault message  
4 Burner operation display  
5 Heating flow temperature

### 3.5 Description of button functions

Button	Meaning
	- Selecting hot water handling mode
	- Selecting heating mode
 or 	- Setting the hot water temperature Setting the heating flow temperature
	- Reset the product
On/off	- Switching the product on/off

Adjustable values flash in the display.

## 4 Operation

### 4.1 Starting up the product

#### 4.1.1 Opening the isolator devices

**Conditions:** The competent person who installed the product will explain where the isolator devices are and how to handle them.

- ▶ Ensure that the valves are open.

#### 4.1.2 Switching on the product

- ▶ Press the on/off button.
  - ◁ As soon as the product is supplied with power, the display switches on. After a few seconds, the product is ready for operation.

### 4.2 Checking the pressure in the heating installation



#### Note

When checking the pressure, there must be no heating demand and/or no hot water request.

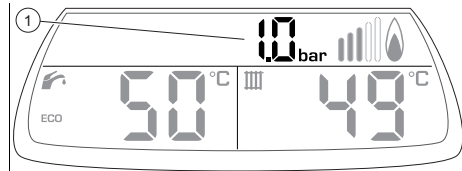

- 1 Current filling pressure
  - ▶ Check the filling pressure for the product once a month.
    - Recommended filling pressure: 1 ... 1.5 bar (100,000 ... 150,000 Pa)
    - ◁ If the filling pressure is correct, no action needs to be taken.
    - ▽ If the filling pressure is too low, add more water to the heating installation.



## 4.3 Filling the heating installation



### Caution.

**Risk of material damage due to heating water that is extremely calciferous or corrosive or contaminated by chemicals.**

Unsuitable tap water damages the seals and diaphragms, blocks components in the product and heating installation through which the water flows and causes noise.

- ▶ Only fill the heating installation with suitable heating water.
- ▶ In case of doubt, ask a competent person for details.



### Note

The competent person is responsible for filling the heating installation the first time, any subsequent top-ups and the water quality.

Of these duties, only the task of adding water to the heating installation may be undertaken by the operator.

1. Open all radiator valves (thermostatic radiator valves) of the heating installation.
2. Slowly open the filling cock on the underside of the product in the way you were shown by the competent person.
3. Fill with water until the required filling pressure is reached.
  - Recommended filling pressure: 1 ... 1.5 bar (100,000 ... 150,000 Pa)
4. Check the filling pressure in the display.
5. Close the filling cock after filling.

## 4.4 Selecting the operating mode



### Note

After every ignition, the product runs in "Heating + hot water" mode.

The button lights up when the operating mode is activated.

1. Press the button to activate/deactivate hot water operating mode.
2. Press the button to activate/deactivate heating mode.

Symbol	Operating mode
	Heating + hot water
	Heating only
	Hot water and frost protection only
–	Absence/frost protection

## 4.5 Setting the hot water temperature

**Conditions:** The temperature is controlled by the boiler

- ▶ Press the or buttons to set the hot water temperature.

**Conditions:** The temperature is controlled by the room thermostat

- ▶ Set the hot water temperature on the room thermostat.



### Note

If you press the , or button, the display shows .

### 4.5.1 Switching ECO mode on and off

- ▶ Set the hot water temperature.

## 4 Operation

**Conditions:** Hot water temperature: < 50 °C



-  mode is shown on the display.

**Conditions:** Hot water temperature: ≥ 50 °C

-  mode is not shown on the display.

### 4.6 Setting the heating flow temperature

**Applicability:** Without the outside temperature sensor, Without the room thermostat

- ▶ Use  (III) or  (III) to set the heating flow temperature.





#### Note

The competent person may have adjusted the minimum and maximum possible temperature.

**Applicability:** Room thermostat

- ▶ Use  (III) to set the heating flow temperature to the maximum value.
- ▶ Set the required heating temperature at the room thermostat.
  - ◁ The actual heating flow temperature is automatically regulated by the room thermostat.

**Applicability:** Outside temperature sensor

- ▶ It is not possible to set the heating flow temperature, even if you press the  (III) or  (III) button.
  - ◁ The display shows the heating flow temperature calculated by the boiler.
  - ◁ The actual heating flow temperature is automatically regulated by the boiler.

## 4.7 Frost protection

### 4.7.1 The product's frost protection function

The frost protection function switches on the boiler and the pump as soon as the safety temperature in the heating circuit is reached.

- Protection temperature: 12 °C

The pump stops once the minimum water temperature in the heating circuit is reached.

- Minimum water temperature: 15 °C

Once the burner ignition temperature in the heating circuit is reached, the burner ignites until the switch-off temperature is reached.

- Burner ignition temperature: 7 °C
- Burner switch-off temperature: 35 °C

The hot water circuit (cold and hot water) is not protected by the boiler.

Frost protection for the system can only be guaranteed by the boiler.

A controller is required to control the temperature of the system.

### 4.7.2 Frost protection for the system



#### Note

Make sure that the product's power supply and the gas supply are working correctly.

**Conditions:** If you are away from home for several days, Without controller

- ▶ Select the Away from home/frost protection (→ Page 9) mode.
  - ◁ Only the water pressure is visible in the heating circuit.

**Conditions:** If you are away from home for several days, With controller

- ▶ Program the number of days you will be away in the controller to activate the frost protection devices.

**Conditions:** If you are away from home for a prolonged period

- ▶ Contact a qualified competent person, who can completely drain the system or protect the heating circuit by adding a special frost protection agent for heating installations.

## 5 Troubleshooting

### 5.1 Detecting and rectifying faults

- ▶ If problems occur whilst operating the product, you can carry out certain self-checks with the aid of the table in the appendix.  
Troubleshooting (→ Page 13)
- ▶ If the product still does not work without any problems after the checks have been carried out using the table, contact Customer Service to rectify the problem.

### 5.2 Fault codes in the display

Fault codes have priority over all other displays. If several faults occur at the same time, the corresponding codes are displayed alternately for two seconds each.

- ▶ If your product displays  $\leftarrow F \square xx$ , contact Customer Service.

## 6 Care and maintenance

### 6.1 Maintenance

An annual inspection and biennial maintenance of the product carried out by a competent person is a prerequisite for ensuring that the product is permanently ready and safe for operation, reliable, and has a long working life.

### 6.2 Caring for the product



#### **Caution.**

**Risk of material damage caused by unsuitable cleaning agents.**

- ▶ Do not use sprays, scouring agents, detergents, solvents or cleaning agents that contain chlorine.

- ▶ Clean the casing with a damp cloth and a little solvent-free soap.

### 6.3 Checking the condensate drain pipework and tundish

- ▶ Regularly check the condensate drain pipework and tundish for faults and, particularly, for blockages.

You must not be able to see or feel any obstructions in the condensate drain pipework and tundish.

- ▶ If you notice a fault, have it rectified by Customer Service.

## 7 Decommissioning

### 7 Decommissioning

#### 7.1 Temporarily decommissioning the product

- ▶ Temporarily decommission the product only if no frost is expected.
- ▶ Switch off the product via the main switch installed on-site.
  - ◀ The display goes out.
- ▶ When decommissioning the product for an extended period (e.g. holiday), you should also close the gas isolator cock and the cold water stop cock.

#### 7.2 Permanently decommissioning the product

- ▶ Have the product permanently decommissioned by Customer Service.

## 8 Recycling and disposal

- ▶ The competent person who installed your product is responsible for the disposal of the packaging.



If the product is identified with this symbol:

- ▶ In this case, do not dispose of the product with household waste.
- ▶ Instead, hand in the product to a collection centre for old electrical or electronic appliances.



If the product contains batteries that are marked with this symbol, these batteries may contain substances that are hazardous to human health and the environment.

- ▶ In this case, dispose of the batteries at a collection point for batteries.

## 9 Guarantee and customer service

### 9.1 Guarantee

For information on the manufacturer's guarantee, you can write to the contact address that is provided on the back page.

### 9.2 Customer service





For contact details for our customer service department, you can write to the address that is provided on the back page, or you can visit [www.glow-worm.co.uk](http://www.glow-worm.co.uk).

## Appendix

### A Troubleshooting

Fault	Cause	Remedy
No hot water, heating stays cold; product does not start	Building gas isolator cock closed	Open the building-side gas isolator cock
	Building power supply switched off	Switch on building power supply
	On/off button on product switched off	Switch on the on/off button on the product
	The heating flow temperature is set too low, the heating water or hot water handling mode is switched off and/or the hot water temperature is set too low.	Select the required operating mode Set the heating flow temperature and/or hot water temperature to the required temperature
	Filling pressure of the heating installation insufficient	Add more water to the heating installation
	Air in the heating installation	Purging the radiators If the problem occurs again: Inform the competent person
	Ignition malfunction	Press the fault clearance key If the problem occurs again: Inform the competent person
Hot water handling mode without any problems; heating does not start	No heat requirement via the controller	Check the timer programme on the controller and correct if necessary Check the room temperature and, if required, correct the target room temperature ("Controller operating instructions")
	The heating flow temperature is set too low or heating mode is switched on	Switch on heating mode Set the heating flow temperature to the required temperature
	Air in the heating installation	Purging the radiators If the problem occurs again: Inform the competent person
No hot water, heating mode working correctly	The hot water temperature set is too low or hot water handling mode is switched off	Switch on hot water handling mode Set the hot water temperature to the required temperature
Traces of water under the product	Condensate drain pipework blocked	Check and, if required, clean the condensate drain pipework
	Leak in the system or the product	Close the cold water supply to the product, inform a competent person

## Appendix

Fault	Cause	Remedy
The display shows  r E 5 E t	Fault	Press the fault clearance key (Reset)  r E 5 E t and wait for five seconds. If the fault persists, inform a competent person.
The display shows  and the pressure display flashes < 0.5 bar ( < 50,000 Pa)	Low water pressure in the system	Add treated water If the problem occurs again: Inform the competent person
The pressure display flashes ≥ 2.5 bar ( ≥ 250,000 Pa)	The system pressure is too high	Purge a radiator If the problem occurs again: Inform the competent person
The display shows  r F 0 x x and the pressure display flashes	Fault message	Inform a competent person



**Publisher/manufacturer**

**Glow-worm**

Nottingham Road – Belper – Derbyshire DE56 1JQ



0020201110\_00 - 06.02.2015 14:41:44

© These instructions, or parts thereof, are protected by copyright and may be reproduced or distributed only with the manufacturer's written consent.

**Glow-worm**  
The energy you need