

For the operator

Instructions for use



VRC 470

Weather compensator

GB, IE

Legal information

Document type:	Instructions for use
Product:	VRC 470
Target group:	Operator
Language:	EN
Document number_version:	0020116689_01
Created on:	11.10.2012

Publisher/manufacturer

Vaillant GmbH

Berghauser Str. 40 ■ D-42859 Remscheid
Telefon +49 21 91 18-0 ■ Telefax +49 21 91 18-28 10
info@vaillant.de ■ www.vaillant.de

© Vaillant GmbH 2012

These instructions, or extracts thereof, may only be printed with the written consent of Vaillant GmbH.
All designations of products in these instructions are brand names/trade marks of the companies in question.
We reserve the right to make technical changes.

Contents

1	Notes on the documentation	4
1.1	Observing other applicable documents	4
1.2	Document storage	4
1.3	Applicability of the instructions	4
1.4	Nomenclature	4
2	Safety	5
2.1	Action-related warnings	5
2.2	Required personnel qualifications	5
2.3	General safety information	5
2.4	CE label	6
2.5	Intended use	6
3	Overview of the equipment.....	7
3.1	Unit design.....	7
3.2	Identification plate.....	7
3.3	Serial number	7
3.4	Control function.....	7
3.5	Frost protection function	8
4	Operating.....	8
4.1	Operating structure	8
4.2	Operating concept	9
4.3	Overview of setting and read-out options	11
5	Operating and display functions.....	11
5.1	Information.....	11
5.2	Settings.....	13
5.3	Operating modes	18
5.4	Advanced functions	20
5.5	Messages	21
6	Service and troubleshooting	22
6.1	Cleaning the controller.....	22
6.2	Detecting and rectifying faults	22
7	Decommissioning.....	22
7.1	Replacing the controller.....	22
7.2	Recycling and disposal	22
8	Guarantee and customer service	22
8.1	Guarantee.....	22
8.2	Customer service.....	22
9	Technical data.....	22
9.1	Controller	22
9.2	Sensor resistances	22
	Appendix.....	23
A	Operating modes	23
B	Overview of operating levels	23
	Index.....	29

1 Notes on the documentation

1 Notes on the documentation

1.1 Observing other applicable documents

- ▶ You must observe all instructions for use that are enclosed with other components of your system.

1.2 Document storage

- ▶ Store the enclosed operating instructions and all other applicable documents in such a way that they are available whenever required and for any subsequent operators of the system.

1.3 Applicability of the instructions

These instructions apply for the following products only:

VRC 470/3 and VRC 470/4 article number

Great Britain	0020108130
---------------	------------

1.4 Nomenclature

The term "heat pump" is used if there is no difference between the heat pumps.

The term "hybrid heat pump" is used when the **VWS 36/4 230 V** or **VWL 35/4 S 230 V** heat pump is meant.

The term "monoblock heat pump" is used when the **VWL 85/2 A 230 V**, **VWL 115/2 A 230 V**, or **VWL 115/2 A 400 V** heat pump is meant.

2 Safety

2.1 Action-related warnings

Classification of action-related warnings

The action-related warnings are classified in accordance with the severity of the possible danger using the following warning signs and signal words:

Warning symbols and signal words



Danger!

Imminent danger to life or risk of severe personal injury



Danger!

Risk of death from electric shock



Warning.

Risk of minor personal injury



Caution.

Risk of material or environmental damage

2.2 Required personnel qualifications

These instructions are aimed at those who are able to operate a heating installation but do not have any special technical knowledge or experience.

2.2.1 Instructed operator (Operator)

Definition:

Instructed operator	<p>The operator is charged with operation and maintenance of the unit. He/she must ensure compliance with maintenance intervals. He/she does not require any special technical knowledge or experience.</p> <p>The operator must have been instructed in the following topics by the authorised skilled tradesman.</p> <ul style="list-style-type: none"> – General safety information – Function and location of safety devices on the system – Operation of the unit – Energy-saving operation – Maintenance operations
---------------------	--

2.3 General safety information

2.3.1 Installation only by a skilled tradesman

Installation of the unit can be only carried out by an approved, skilled tradesman. This skilled tradesman is also responsible for proper installation and start-up.

2.3.2 Risk of death from contaminated drinking water

The controller is equipped with an Anti-legionella function to protect against infection by germs (Legionella). When this Anti-legionella function is activated, the water in the domestic hot water cylinder is heated to over 60 °C for at least an hour. The skilled tradesman activates the Anti-legionella function on installation of the controller.

- ▶ Ask the skilled tradesman if he has activated the Anti-legionella function.
- ▶ Ask the skilled tradesman to explain how the Anti-legionella function works.

2.3.3 Risk of scalding from hot drinking water

There is a risk of scalding at the hot water draw-off points if the set target temperature is greater than 60 °C. Young children and elderly persons are particularly at risk, even at lower temperatures.

- ▶ Select a moderate set target temperature.

If the Anti-legionella function is activated, discuss with your competent person:

- when the anti-legionella function starts,
- when the hot water is cooled back down to the set target temperature,
- whether a mixer valve is incorporated in your heating installation as protection against scalding,
- what do you have to do to avoid scalding.

2.3.4 Danger caused by a malfunction

- ▶ Ensure that air can circulate freely around the controller, and that the controller is not covered by furniture, curtains or other objects.
- ▶ Ensure that all radiator valves in the room where the controller is fitted are fully open.
- ▶ Only operate the heating installation when it is in a technically perfect condition.
- ▶ Ensure that any faults and damage that may negatively affect safety are rectified immediately.

2.3.5 Frost damage caused by switching the appliance off

If you switch off the heating installation, parts of the heating installation may be damaged by frost.

- ▶ Do not disconnect the heat generator from the mains power.
- ▶ Leave the heating installation main switch in the "1" position.



2 Safety



2.3.6 Frost damage caused by excessively low room temperature

If the room temperature is set too low in individual rooms, sections of the heating installation might be damaged by frost.

- ▶ If you are absent during a frosty spell, ensure that the heating installation remains in operation and the rooms are warmed adequately.
- ▶ Please note the frost protection function.

2.3.7 Moisture and mould damage due to inadequate exchange of air

In heavily insulated rooms that only allow a small exchange of air, moisture and mould damage may occur.

- ▶ Ventilate the rooms regularly by opening windows and activate the **1 x ventilation boost** function once to save energy.

If a ventilation unit is connected (applies for controller version VRC 470/4):

- ▶ Do not disconnect the ventilation unit from the power mains.
- ▶ Clean and service the ventilation unit. The instructions for cleaning and maintenance can be found in the ventilation unit manual.

2.4 CE label



The CE label shows that the products comply with the basic requirements of the applicable directives as stated on the identification plate.

2.5 Intended use

State-of-the-art

The controller is a state-of-the-art unit manufactured in accordance with recognised safety regulations.

Even so, in the event of inappropriate or non-intended use, damage to the appliance and other property may arise.

The controller controls a heating system with a Vaillant boiler with eBUS interface in a way that is weather-controlled and time-dependent.

The controller can control the hot water generation from a connected DHW cylinder.

If a circulation pump is connected, the controller can also control the hot water supply and circulation.

The controller can control a connected ventilation unit with an eBUS interface on a time-dependent basis.

Improper use

Any other use that is not specified in these instructions, or use beyond that specified in this document shall be considered improper use. Any direct commercial or industrial use is also deemed to be improper. The manufac-

turer/supplier is not liable for any claims or damage resulting from improper use. The user alone bears the risk.

Any improper use is prohibited.

Other applicable documents

Intended use includes the following:

- observance of accompanying operating, installation and servicing instructions for the Vaillant product as well as for other parts and components of the system
- compliance with all inspection and maintenance conditions listed in the instructions.

3 Overview of the equipment

3.1 Unit design

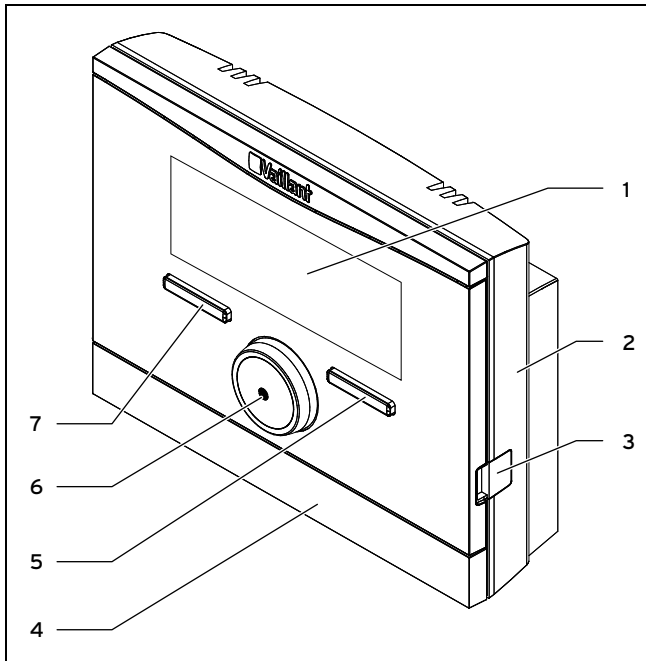

- | | |
|----------------------|-------------------------------|
| 1 Display | 5 Right-hand selection button |
| 2 Wall-mounting base | 6 Rotary knob |
| 3 Diagnostics socket | 7 Left-hand selection button |
| 4 Wall base strip | |

3.2 Identification plate

The identification plate is located inside the controller and is not accessible from the outside.

3.3 Serial number

The 10-digit article number can be found in the serial number. You can view the serial number under **Menu** → **Information** **Serial number**. The article number is found in the second line of the serial number.

3.4 Control function

The controller controls the Vaillant heating installation, the connected ventilation unit and hot water generation of a connected domestic hot water cylinder.

If the controller is installed in a living room, you can operate the heating system, connected ventilation unit and hot water generation from a living room.

3.4.1 Heating installation

3.4.1.1 Heating

You can use the controller to set the desired temperature for different times of the day and for different days of the week.

The controller is a weather compensator with a temperature sensor fitted in the open air. The temperature sensor measures the outside temperature and sends the values to the controller. When the outside temperature is low, the controller increases the flow temperature of the Vaillant heating installation. When the outside temperature rises, the controller reduces the flow temperature. Thus, the controller reacts to fluctuations in the outside temperature and, via the flow temperature, keeps the room temperature constantly at the set desired temperature.

3.4.1.2 Cooling

The room temperature sensor measures the room temperature and forwards the data on to the controller. If the room temperature is higher than the desired temperature that is set, the controller reduces the flow temperature.

3.4.1.3 Ventilation

Applies to: Controller version VRC 470/4

If a ventilation unit is connected, the controller supports the ventilation function.

You can use the controller to set the desired ventilation level and time for the ventilation.

3.4.1.4 VR 61/4 mixer module

If a **VR 61/4** mixer module is connected, the controller can control two heating circuits:

- two heating circuits independently of each other, e.g. **HEATING 1** in a single-occupancy house and **HEATING 2** in a guest apartment in this house.
- two heating circuits dependent on each other in a dwelling, e.g. **HEATING 1** for radiators and **HEATING 2** for underfloor heating.

3.4.1.5 Hybrid manager

If you have connected a heat pump, the hybrid manager attempts to cover the declared energy requirement under the considerations of the cost optimisation and the technical conditions.

The price-oriented hybrid manager picks the heat generator on the basis of the rates set in relation to the energy requirement.

The bivalence point hybrid manager picks the heat generator on the basis of the outside temperature.

If the system declares an energy requirement, the hybrid manager switches on and forwards the energy requirement to the heat generator. The hybrid manager determines which heat generator it activates.

4 Operating

3.4.2 Hot water generation

You can use the controller to set the temperature and time for the hot water generation. The heat generator heats the water in the domestic hot water cylinder until it reaches the set temperature. You can set a time period during which hot water should be available in the domestic hot water cylinder.

3.4.3 Circulation

If a circulation pump is installed in the heating installation, you can set a period for circulation. During the set period, hot water circulates from the domestic hot water cylinder to the water taps and back to the domestic hot water cylinder. If, for example, you turn on a water tap during this time, hot water will come out of the tap immediately.

3.5 Frost protection function

The frost protection function protects the heating system and apartment from frost damage. The frost protection function monitors the outside temperature.

If the outside temperature

- falls below 3 °C, the controller switches the heater on after a frost protection delay time, and brings the target room temperature to 5 °C.
- rises above 4 °C, the controller does not switch the heater on but monitors the outside temperature.



Note

Your competent person will set the frost protection delay time during the installation.

3.5.1 Enhanced frost protection function

If the heat pump is connected and you have activated the **Cooling** operating mode, the additional enhanced frost protection function is also available.

- If the outside temperature falls below 4 °C for longer than 10 minutes, the controller switches off the **Cooling** operating mode.

4 Operating

4.1 Operating structure

4.1.1 Access level for the operator

Through the access level for the operator, you access important information and set-up options which do not require any special prior knowledge. Via a menu structure, you can access configurable or read-only values.

4.1.2 Access level for the skilled tradesman

The skilled tradesman will set further values for the heating installation via the access level for the skilled tradesman. The settings may only be made by someone with specialist knowledge; this level is therefore code-protected.

4.1.3 Menu structure design

The menu structure of the controller is split into four levels. There are three selection levels and one setting level. From the basic display, you access selection level 1 and, from there, you can access the menu structure for one level up or down. The setting level is accessed from the lowest selection level.

4.1.4 Basic display

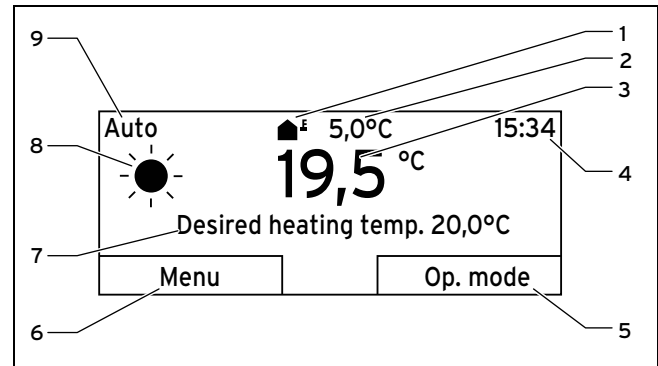

- | | | | |
|---|---|---|--|
| 1 | Symbol for the current outside temperature | 6 | Current function of the left-hand selection button |
| 2 | Current outside temperature | 7 | Desired setting (e.g. desired heating temp.) |
| 3 | Current room temperature | 8 | Symbol for Auto operating mode |
| 4 | Time | 9 | Operating mode set |
| 5 | Current function of the right-hand selection button | | |

The basic display shows the current settings and values of the heating installation. If you make a setting on the controller, the display on the screen switches from the basic display to the display with the new setting.



The basic display appears when you:

- press the left-hand selection button and thus exit selection level 1.
- do not operate the controller for more than 5 minutes.

The basic display shows the key displays heating, cooling and ventilation and the corresponding operating modes as well as the status of the time period.

If your heating installation has two independent heating circuits, the competent person will determine during installation whether or not the basic display shows the values of **HEATING 1** or **HEATING 2**.

4.1.4.1 Symbols for Auto mode

Symbol	Meaning
	Comfort mode: Within a set time period
	Set-back mode: Outside a set time period

4.1.4.2 Soft key function

Both selection buttons have a soft key function. The current functions of the selection buttons are displayed in the bottom display line. Depending on the selection level selected in the menu structure, the list entry or the value, the current function for the left and right selection buttons may be different.

If, for instance, you press the left-hand function key, the current function of the left function key switches from **Menu** to **Back**.

4.1.4.3 Menu

If you press the left-hand selector button, **Menu**, you switch from the basic display to selection level 1 of the menu structure.

4.1.4.4 Operating mode

If you press the right-hand selection button, **Operating mode**, you access the settings directly from the basic display under **Operating mode**.

4.1.4.5 Desired setting

Depending on the basic setting selected, a different display text appears, e.g.:

- For the **Heating** basic setting, **Desired Heating temp** appears
- For the **Cooling** basic setting, **Desired Cooling temp** appears
- For the **Ventilation** basic setting, the ventilation level appears
- Depending on the operating mode selected, no display text appears

4.1.5 Selection level

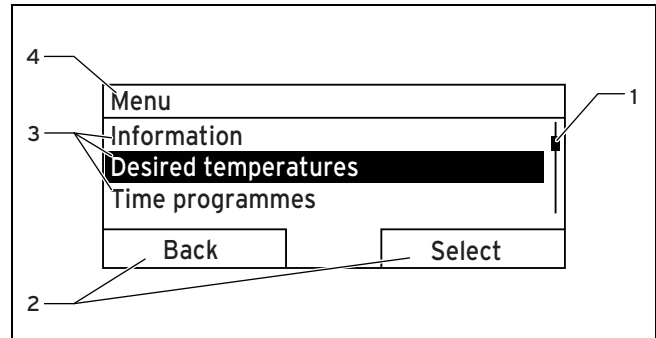

- | | |
|---|---------------------------------------|
| 1 Scroll bar | 3 Selection level list entries |
| 2 Current functions of the right and left selection buttons | 4 Current function or selection level |

Through the selection levels, you navigate to the setting level in which you wish to read or change settings.

4.1.6 Setting level

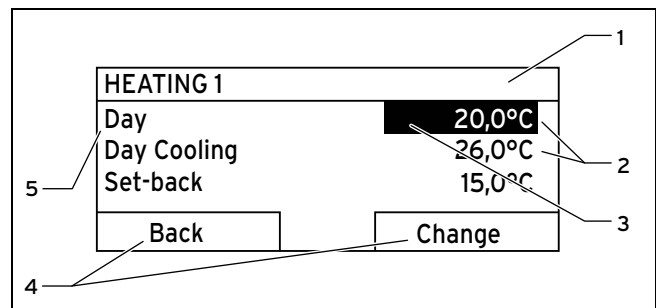

- | | |
|---------------------------------|---|
| 1 Current selection level | 4 Current functions of the right and left selection buttons |
| 2 Values | 5 Setting level |
| 3 Selection (current selection) | |

In the setting level, you can select the values you wish to read or change.

4.2 Operating concept

The controller is operated using two selection buttons and a rotary knob.

The display shows a highlighted selection level, a setting level or a highlighted value with white font on a black background. A flashing, highlighted value means that you can change the value.

If you do not operate the controller during a period of more than 5 minutes, the basic display appears again.

4.2.1 Example: Operation in the basic display

From the basic display, you can change the **Desired day temperature** directly for the current day by turning the rotary knob.

4 Operating

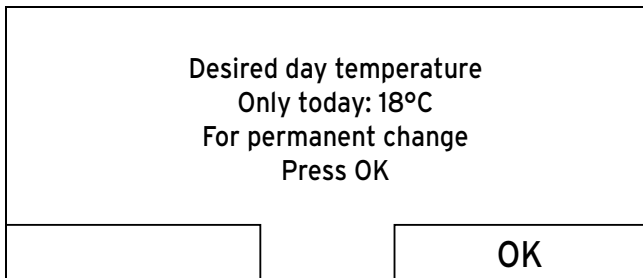

In the display, a request appears asking if you want to change the **Desired day temperature** for the current day or on a permanent basis.

4.2.1.1 To change the Desired day temperature for the current day only

- ▶ Turn the rotary knob to set the desired temperature.
 - ◁ The display switches back to the basic display after 12 seconds. The set desired temperature applies only until the end of the active time period of the current day.

4.2.1.2 Changing the Desired day temperature permanently

1. Turn the rotary knob to set the desired temperature.
2. Press the right-hand selection button, **OK**.
 - ◁ The display switches to the basic display. The new desired day temperature is applied permanently.

4.2.2 Operating example, changing the date

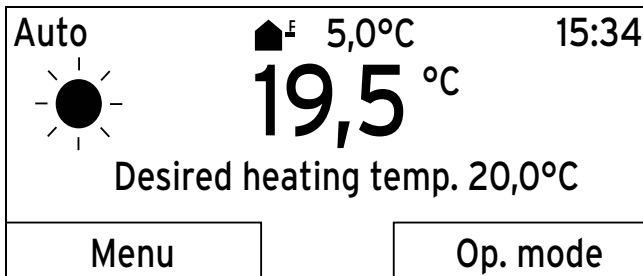

1. If the display does not show the basic display, press the left-hand selection button, **Back**, until the basic display appears again.
2. Press the left-hand selection button, **Menu**.
 - ◁ The controller is now in selection level 1. The left-hand selection button now has the function **Back** (to go back to the previous level), the right-hand selection button has the function **Select** (to select the highlighted menu option).

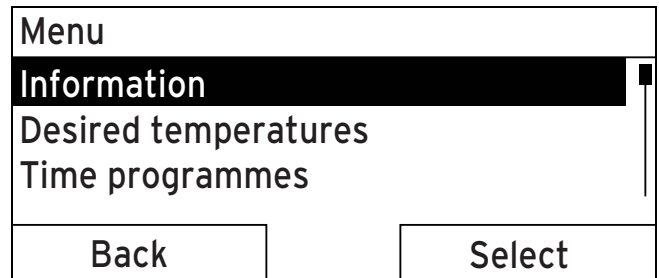

3. Turn the rotary knob until the **Basic settings** list entry is highlighted.

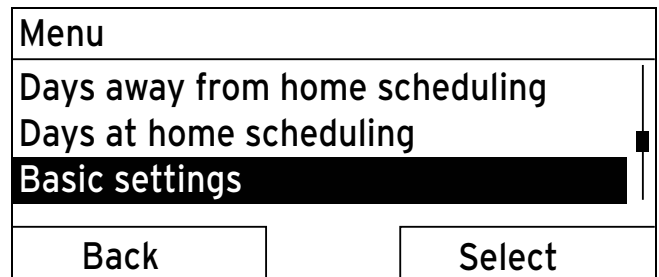

4. Press the right-hand selection button, **Select**.
 - ◁ The controller is now in selection level 2.

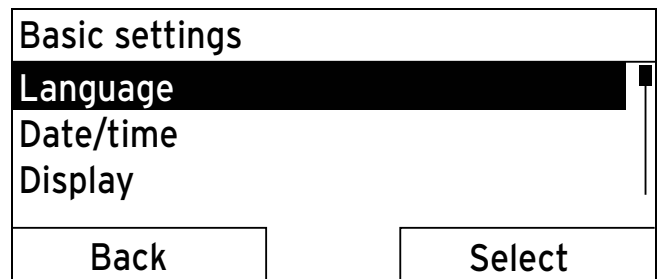

5. Turn the rotary knob until the **Date/Time** list entry is highlighted.

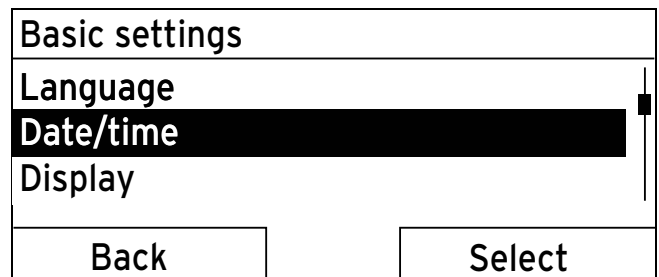

6. Press the right-hand selection button, **Select**.
 - ◁ The controller is now in the **Date** setting level. The value for the day is highlighted. The left-hand selection button now has the function **Back** (to go back to the previous level), the right-hand selection button has the function **Change** (the value).

Date/time	
Date	13.03.11
Time	08:15
Daylight saving time	Off
Back	Change

7. Press the right-hand selection button, **Change**.
 - ◁ The highlighted value starts to flash; you can now change the value by turning the rotary knob.
 - ◁ The left-hand selection button now has the function **Cancel** (the change); the right-hand selection button has the function **OK** (to confirm the change).

Date/time	
Date	13.03.11
Time	08:15
Daylight saving time	Off
Cancel	OK

8. Turn the rotary knob to change the value.

Date/time	
Date	14.03.11
Time	08:15
Daylight saving time	Off
Cancel	OK

9. Press the right-hand selection button, **OK**, to confirm the change.
 - ◁ The controller has stored the changed date.

Date/time	
Date	14.03.11
Time	08:15
Daylight saving time	Off
Back	Change

10. If the highlighted value that is flashing is correct, press the right-hand selection button **OK** again.
 - ◁ The left-hand selection button now has the function **Back**.
11. Press the left-hand selector button **Back** repeatedly to revert back to the previous level and to access the basic display from selection level 1.

4.3 Overview of setting and read-out options

4.3.1 Overview of operating levels

If **HEATING 1** and **HEATING 2** are referred to in the path specification in the table, the description of functions applies to both heating circuits.

Overview of operating levels (→ Page 23)

5 Operating and display functions

The path details given at the start of each function description indicate how you reach this function in the menu structure.

If **HEATING 1** and **HEATING 2** are referred to in the path specification, the description of functions applies to both heating circuits.

You can use the left-hand selection button **Menu** to set the operating and display functions.

5.1 Information

5.1.1 Reading the system status

Menu → **Information** → **System status**

- The **System status** option shows you a list of system parameters and their current settings/levels.

Furthermore, it gives you information on active time periods (**Auto day temp until**) and exceptions in the time programmes, which you may have set with the **Days away from home** and **Days at home** functions.

You can set some values directly under **System status**, such as the desired temperatures for **Day temp. heating**, **Night temp. heating** and **Day temp. cooling**. All other values are set in other places in the menu structure, as described in the following sections.

5.1.2 Reading the list of status messages

Menu → **Information** → **System status** → **Status**

- If no service is required and no errors have occurred, the value **OK** is shown next to **Status**. If a service is required or an error has occurred, the value **Fault** is shown next to **Status**. In this case, the right-hand selector button has the function **Display**. If you press the right-hand selector button **Display**, the list of status messages is shown in the display.

5.1.3 Solar

If a **VR 68/2** solar module or a **VMS** solar pump unit is connected, then additional list entries appear under **System status**.

Menu → **Information** → **System status** → **Collector temp**

- This function allows you to read the current temperature at the collector sensor.

Menu → **Information** → **System status** → **Solar yield**

- This function allows you to read the total solar yield.

5 Operating and display functions

Menu → Information → System status → Reset solar yield

- If you select the setting **Yes** under function **Reset solar yield** and press the right-hand selection button, **OK**, you reset the previously totalled solar yield to 0 kWh. After 30 seconds, the setting **Yes** automatically returns to **No**. This only applies for the **VR 68/2** solar module.

5.1.4 Heat pump

If a heat pump is connected, additional list entries appear under **System status**.

5.1.4.1 Reading the environment yield

Menu → Information → System status → Environment yield

- This function allows you to read the total environment yield.

5.1.4.2 Resetting the environment yield

Menu → Information → System status → Reset environment yield

- If you select the setting **Yes** under the function **Reset environment yield** and press the right-hand selection button, **OK**, you reset the previously totalled environment yield to 0 kWh. After 30 seconds, the setting **Yes** automatically returns to **No**.

5.1.4.3 Reading the electrical consumption

Menu → Information → System status → Electrical consumption

- This function allows you to read the total electrical consumption.

5.1.4.4 Resetting the electrical consumption

Menu → Information → System status → Reset electrical consumption

- If you select the setting **Yes** under the function **Reset electrical consumption** and press the right-hand selection button, **OK**, you reset the previously totalled electrical consumption to 0 kWh. After 30 seconds, the setting **Yes** automatically returns to **No**.

5.1.5 Read current room air humidity

Menu → Information → System status → Curr. room air humidity

- You can use this function to read the current room air humidity. The room air humidity sensor is installed in the controller.

5.1.6 Reading the current dew point

Menu → Information → System status → Current dew point

- This function allows you to read the current dew point. The dew point indicates the temperature at which the water vapour in the air condenses and settles on objects.

5.1.7 Reading triVAI

Menu → Information → System status → triVAI

- If you have connected a hybrid heat pump, you can use the **triVAI** function.

This function allows you to read whether the heat pump, value greater than 1, or the auxiliary boiler (gas, oil or electricity), value smaller than 1, is currently covering the energy requirement.

5.1.8 Reading the solar statistics

Menu → Information → Solar yield

- The diagram under **Solar yield** shows a comparison of the monthly solar yields between the previous and the current year.
- The total yield is displayed on the bottom right. The highest value achieved in one month for the last two years is displayed in the top right.

5.1.9 Reading the environmental statistics

Menu → Information → Environment yield

- The diagram under **Environment yield** shows a comparison of the monthly environment yields between the previous and the current year.
- The total yield is displayed on the bottom right. The highest value achieved in one month for the last two years is displayed in the top right.

5.1.10 Reading the power statistics

Menu → Information → Electrical consumption

- The diagram under **Electrical consumption** shows a comparison of the monthly consumption of electricity between the previous and the current year.
- The total yield is displayed on the bottom right. The highest value achieved in one month for the last two years is displayed in the top right.

5.1.11 Read skilled tradesman contact details

Menu → Information → Contact details

- If the skilled tradesman entered their company name and telephone number during the installation, you can read this data under **Contact details**.

5.1.12 Reading the serial number and article number

Menu → Information → Serial number

- **Serial number** shows the serial number of the controller, which the competent person may require you to tell

him. The article number is found in the second line of the serial number.

5.2 Settings

5.2.1 Setting desired temperatures

This function is used to set the desired temperatures for the heating circuit and hot water generation.

If a **VR 61/4** mixer module is connected, **HEATING 2** also appears under **Desired temperatures**. **HEATING 2** has the same read-out options and settings as **HEATING 1**.

If a heat pump is connected and the cooling function is available, the **HEATING 1** and, where required, **HEATING 2** displays also show the entry **Day cooling**.

5.2.1.1 Heating circuit



Caution. Risk of damage due to frost.

If rooms are not adequately heated, this may cause damage to the building and to the heating installation.

- ▶ If you are absent during a frosty spell, ensure that the heating installation remains in operation and provides adequate frost protection.

Menu → **Desired temperatures** → **HEATING 1** and if necessary **HEATING 2**

- You can set different desired temperatures for the heating circuit:

Heating

The desired **Day** temperature is the temperature you wish to have in the rooms during the day or when you are at home (Comfort mode). The desired **Set-back** is the temperature that you wish to have in the rooms during the night or when you are away from home (Set-back mode).

Cooling

The desired **Day cooling** temperature is the temperature you wish to have in the rooms during the day or when you are at home (Comfort mode).

5.2.1.2 Hot water generation



Danger! Risk of being scalded by hot water.

There is a danger of scalding at the hot water draw-off points if the temperatures are greater than 60 °C. Young children and elderly persons are particularly at risk, even at lower temperatures.

- ▶ Select the temperature so that nobody is at risk.

Menu → **Desired temperatures** → **Domestic hot water**

- You can only use the controller's functions and setting options for hot water generation if a domestic hot water cylinder is connected to the heating installation.

You can set the desired **Hot water circuit** temperature for the hot water circuit.

5.2.2 Setting the ventilation level

Applies to: Controller version VRC 470/4

Menu → Ventilation level

- You can use the controller's functions and setting options for ventilation if a ventilation unit is connected to the heating installation.

This function allows you to set how quickly the used room air is replaced with fresh outside air.

The **Max. day ventilation level** ventilation level ensures the rate of exchange of air that you want in rooms during the day or when you are at home (comfort mode). The **Max. set-back ventilation level** ventilation level ensures the rate of exchange of air that you want in rooms during the night or when you are not at home (set-back mode). The instructions for use for the ventilation unit explain how the ventilation unit works with the ventilation levels.

5.2.3 Setting time programmes

5.2.3.1 Displaying time periods for one day

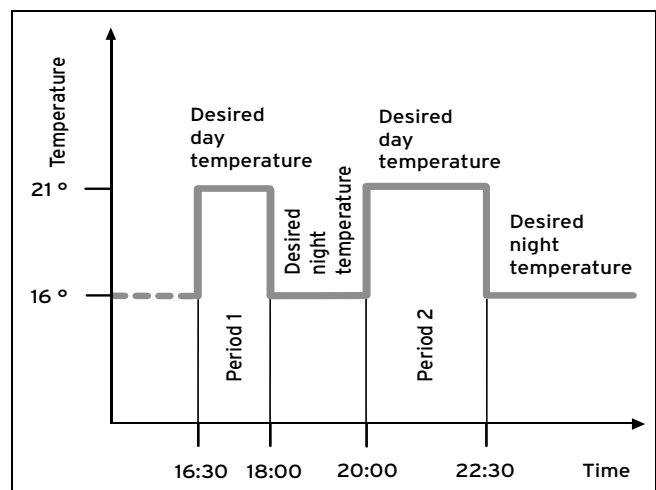

The **Time programmes** function can be used to set the time period for the heating circuit, ventilation unit, hot water generation and circulation pump.

If you have not set any time periods, the controller uses the time periods set in the factory settings.

If a **VR 61/4** mixer module is connected, the **Time programmes** display also shows **HEATING 2**. **HEATING 2** has the same read-out options and settings as **HEATING 1**.

If a heat pump is connected and the cooling function is available, the **Time programmes** display also shows the **Heating circuit 1: Cooling** and, where required, **Heating circuit 2: Cooling**.

5 Operating and display functions

Applies to: Controller version VRC 470/4

If a ventilation unit is connected and ventilation is available, an additional list entry appears under **Time programmes**.

5.2.3.2 Setting time periods for days and blocks

For each day and block, you can set up to three time periods.

The time periods set for a day have priority over the time periods set for a block.

Desired temperature **Day**: 21 °C

Desired temperature **Night**: 16 °C

Time period 1: 06.00 - 08.00

Time period 2: 16.30 - 18.00

Time period 3: 20.00 - 22.30

Within the time periods, the controller brings the room temperature to the set desired **Day** temperature (Comfort mode).

Outside the time period, the controller brings the room temperature to the set desired **Set-back** temperature (Set-back mode).

5.2.3.3 Setting time programmes quickly

If, for example, you require a different time period for just one working day in the week, first set the times for the entire block **Monday - Friday**. Then set the different time period for the working day.

5.2.3.4 Displaying and changing different times in the block

Monday - Sunday	
Period 1:	!! : !! - !! : !!
Period 2:	!! : !! - !! : !!
Period 3:	!! : !! - !! : !!
Back	Select

If you view a block in the display and have defined a different period for a day in this block, then the display indicates the different times in the block with !!.

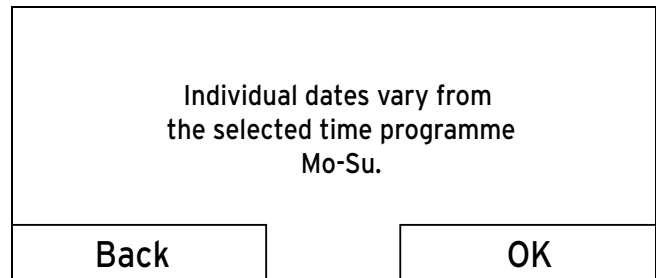

If you press the right-hand selection button **Select**, a message appears on the display which informs you about different periods. You do not need to adjust the times.

The set times for the block marked with !! can be viewed and changed if you press the right-hand selection button **OK** in the display.

5.2.3.5 For the heating circuit

Menu → **Time programmes** → **HEATING 1** and, where required, **HEATING 2**

- The time programmes are only effective in the **Automatic mode** (→ Page 18). In each set time period, the desired temperature that you set in the **Desired temperatures** function applies. Within the time period, the controller switches to Comfort mode and the heating circuit heats the connected rooms up to the desired **Day temperature**. Outside that time period, the controller switches to the operating mode that the competent person has set: Frost protection, Eco or Night temperature.

Set the time period for the heating circuit so that each time period:

- starts approx. 30 minutes before the time at which the rooms should reach the desired **Day temperature**.
- ends approx. 30 minutes before the time at which the rooms should reach the desired **Set-back** temperature.



Note

The competent person can set a pre-heat time and a pre-switch-off time for the heating circuit, so that you can set the time period for the desired **Day** and **Set-back** temperatures exactly to the times at which the room temperature should reach the desired temperature. Ask the competent person whether he has set a pre-heat time or a pre-switch-off time.

5.2.3.6 For the cooling

Menu → **Time programmes** → **Heating circuit 1: Cooling** and, where required, **Heating circuit 2: Cooling**

- The time programmes are effective in **Cooling** mode and in the **Manual cooling** advanced functions. In each set time period, the desired temperature that you set in the **Desired temperatures** function applies. Within the time period, the heating circuit cools the living rooms to the desired **Day cooling** temperature. The heating circuit is not cooled outside of this time period.

5.2.3.7 For hot water generation

Menu → **Time programmes** → **Domestic hot water** → **Preparation**

- You can only use the controller's functions and setting options for hot water generation if a domestic hot water cylinder is connected to the heating installation.

For hot water generation, the time programmes are only effective in **Automatic mode**.

In each time period set, the desired **Domestic hot water** temperature applies. At the end of a time period, the controller switches the hot water generation off until the start of the next time period.

Set the time periods for hot water generation so that each time period:

- starts approx. 30 minutes before the time at which the water in the domestic hot water cylinder should have reached the desired **Hot water circuit** temperature.
- ends approx. 30 minutes before the time at which you no longer need any hot water.

5.2.3.8 For circulation

Menu → **Time programmes** → **Domestic hot water** → **Circulation**

- You can only use the controller's functions and setting options for circulation if secondary returns and a circulation pump are connected to the heating installation.

For circulation, the time programmes are only effective in **Automatic mode**. The set time periods determine the operating times for circulation. Within the time period, the circulation is switched on. Outside the time period, the circulation is switched off.

Set the time periods for circulation so that each time period:

- starts approx. 30 minutes after the start of a time period for hot water generation,
- ends approx. 30 minutes before the end of a time period for hot water generation.

5.2.3.9 For the high tariff periods

Menu → **Time programmes** → **Tariff periods**

- If a heat pump is connected to the heating installation and the price-oriented hybrid manager is selected, you can use the functions and setting options of the controller for the high-tariff periods.

The times of high tariff depend on your energy supplier.

5.2.3.10 For the noise reduction periods

Menu → **Time programmes** → **Noise reduction periods**

- If a heat pump is connected to the heating installation, you can use the functions and setting options of the controller for the noise reduction periods

You can reduce the rotational speed of the heat pump's fan. A reduction in the fan speed also negatively affects the heating output, particularly at low outside temperatures. The efficiency of the heat pump system is reduced.

5.2.3.11 For ventilation

Applies to: Controller version VRC 470/4

Menu → **Time programmes** → **Ventilation**

- If a ventilation unit is connected and ventilation is available, the **Ventilation** entry also appears under time programmes.

The time programmes are only effective in Automatic mode. In each time period set, the ventilation level that you have set with the **Ventilation** function applies. Within the time period, the controller regulates the ventilation unit to a maximum of **Max. day ventilation level**. Outside the time period, the controller regulates the ventilation unit to a maximum of **Max. set-back ventilation level**.

5.2.4 Days away from home scheduling

Menu → **Day away from home scheduling** → **HEATING 1** and if necessary **HEATING 2**

- You can use this function to set a period with a start and end date and a temperature for days during which you are away from home. Thus, you do not need to change time periods for which you have set, for example, no reduction of the desired temperature over the course of the day.

Frost protection is activated.

While the **Days away from home scheduling** function is activated, it has priority over the set operating mode. At the end of the specified period, or if you cancel the function, the heating installation returns to the pre-set mode.

When cooling is available, the **Cooling** function is switched off.



Note

Cooling remains switched on if required by national law. In this case, the competent person adjusts your heating installation in such a way that the **Cooling** function remains switched on at the temperature desired during your absence.

Applies to: Controller version VRC 470/4

When the ventilation unit is connected and ventilation is available, ventilation is set to the lowest level.

5 Operating and display functions

5.2.5 Days at home scheduling

Menu → Day at home scheduling → HEATING 1 and if necessary HEATING 2

- In the specified period, the heating installation works in **Automatic mode** and uses the day settings for **Sunday**, which were set using the **Time programmes** function. At the end of the specified period, or if you cancel the function, the heating installation returns to the pre-set mode.

5.2.6 Language selection



Note

During installation, the skilled tradesman sets the desired language. All functions are displayed in the set language.

Menu → Basic settings → Language

- If the language of e.g. a service technician differs from the set language, you can change the language using this function.



Caution.

It may not be possible to operate the controller if the wrong language is selected.

If you select a language that you do not understand, you can no longer read the text in the controller display and can no longer operate the controller.

- ▶ Only select a language that you understand.

However, if the text in the display should appear in a language that you do not understand, you can set a different language.

5.2.6.1 Setting a language that you understand

1. Press the left-hand selection button repeatedly until the basic display appears.
2. Press the left-hand selection button again.
3. Rotate the rotary knob clockwise until the dotted line appears.
4. Turn the rotary knob anti-clockwise until the second list entry above the dotted line is highlighted.
5. Press the right-hand selection button twice.
6. Turn the rotary knob until you find a language that you understand.
7. Press the right-hand selection button.

5.2.7 Setting the date

Menu → Basic settings → Date/Time → Date

- Select this function to set the current date. All controller functions that contain a date relate to the set date.

5.2.8 Setting the time

Menu → Basic settings → Date/Time → Time

- Select this function to set the current time. All controller functions that contain a time relate to the set time.

5.2.9 Changing over to daylight saving time

Menu → Basic settings → Date/Time → Daylight saving

- You can use this function to set whether the controller automatically changes over to daylight saving time, or whether you want to do this manually.
- **Auto:** The controller automatically changes over to daylight saving time.
- **Off:** You have to change over to daylight saving time manually.



Note

Daylight saving time means Central European summer time: Start = last Sunday in March, End = last Sunday in October.

If the external sensor is equipped with a DCF77 receiver, the daylight saving time setting is irrelevant.

5.2.10 Setting the display contrast

Menu → Basic settings → Display → Display contrast

- You can set the display contrast in relation to the brightness of the surroundings, to ensure that the display is clearly legible.

5.2.11 Setting the preferred display

Menu → Basic settings → Display → Preferred display

- With this function, you can choose whether to see the data for heating, cooling or ventilation in the basic display.

5.2.12 Setting the offset room temperature

Menu → Basic settings → Offset → Room temperature

- The controller can show the current room temperature if it is installed in a living room.

A thermometer is integrated in the controller for measuring the room temperature. If you have another thermometer in the same room and compare the values with each other, the temperature values may constantly differ from each other.

Example

One room thermometer constantly shows a temperature that is one degree higher than the current room temperature on the controller display. With the **Room temperature** function, you can offset the temperature difference in the controller display by setting a correction value of +1 K (1 K corresponds to 1 °C). K (Kelvin) is a unit for the temperature difference. Inputting a correction value affects the room temperature compensator.

5.2.13 Setting the offset outside temperature

Menu → Basic settings → Offset → Outside temperature

- The thermometer in the controller's external sensor measures the outside temperature. If you have fitted another thermometer in the outside area and compare the temperature values with each other, the temperature values may constantly differ from each other.

Example

Your weather station constantly shows an outside temperature that is one degree higher than the current outside temperature on the controller display.

With the **Outside temperature** function, you can offset the temperature difference in the controller display by setting a correction value of -1 K (1 K corresponds to 1 °C). K (Kelvin) is a unit for the temperature difference.

Inputting a correction value affects the weather compensator.

5.2.14 Setting the cooling offset

Menu → Basic settings → Offset → Cooling

- If a heat pump is connected and cooling is available, you can use the **Cooling offset** function.

Cooling is only possible if the outside temperature is higher than the target room temperature for the cooling minus the cooling offset.

Example

If you want the temperature in the living room to be 24 °C, you have set this temperature as the **Desired cooling temp**, and the cooling offset is set to 5 K, the cooling function is only activated once the outside temperature reaches 19 °C.

5.2.15 Setting costs

If the heat pump is connected and the competent person has selected the price-oriented hybrid manager, the price-oriented hybrid manager evaluates the factor/value that was entered for the auxiliary boiler, the high tariff and the low tariff, and actuates the heat generator from the viewpoint of cost optimisation.

You must specify all tariffs in the unit of currency per kWh for the calculation to be correct.

If your energy provider specifies the gas and electricity rate in the unit of currency per m³, ask for the precise gas and electricity rate in the unit of currency per kWh.

Round the amount up or down to one decimal place.

Example

	Costs	Setting/factor
Auxiliary boiler (Gas, oil, electricity)	11.3 currency units/kWh	113
Low electricity tariff (heat pump)	14.5 currency units/kWh	145

	Costs	Setting/factor
High electricity tariff (heat pump)	18.7 currency units/kWh	187

5.2.15.1 Setting the tariff for the auxiliary boiler

Menu → Basic settings → Costs → Auxiliary boiler

- The factor/value that is set requires the hybrid manager to calculate costs correctly.

To set the correct factor/value, you must ask your energy provider what your gas and electricity tariff is.

5.2.15.2 Setting the low electricity tariff

Menu → Basic settings → Costs → Low electricity tariff

- The factor/value that is set requires the hybrid manager to calculate costs correctly.

To correctly set the **Low electricity tariff**, you must ask your energy supplier what your electricity rate is.

5.2.15.3 Setting the high electricity tariff

Menu → Basic settings → Costs → High electricity tariff

- The factor/value that is set requires the hybrid manager to calculate costs correctly.

To correctly set the **High electricity tariff**, you must ask your energy supplier what your electricity rate is.

5.2.16 Activating heat recovery

Applies to: Controller version VRC 470/4

Menu → Basic settings → Heat recovery

- If a ventilation unit with heat recovery is connected, you can use the **Heat recovery** function.

The **Heat recovery** function is normally set to **Auto**, which means that internal regulation checks whether heat recovery makes sense, or whether external air can be guided directly into the living room. For more information, see the **recoVAIR.../4** instructions for use.

If you have selected **Activate**, heat recovery will be used constantly.

5.2.17 Setting the room air humidity

Menu → Basic settings → Room air humidity →

- If the room air humidity exceeds the value set, a connected dehumidifier is activated. As soon as the value drops below the value that is set, the dehumidifier switches off again.

5.2.18 Changing heating circuit naming

Menu → Basic settings → Change heating circuit naming

5 Operating and display functions

- You can now modify the factory-specified heating circuit names as you wish. The name is limited to 10 characters.

5.2.19 Resetting to factory setting

You can reset the settings for the **Time programmes** or for **Everything** to the factory setting.

Menu → **Basic settings** → **Factory reset** → **Time programmes**

- With **Timer programs**, you reset all the settings you have made in the **Timer programs** function to the default setting. All other settings that include times, such as **Date/Time**, are not affected.

While the controller is resetting the timer program settings to the default settings, **In process** is shown on the display. The basic display is then displayed.



Caution.

Risk of a malfunction.

The **Everything** function restores all settings to the factory settings, including those set by the skilled tradesman. It may be the case that it is no longer possible to operate the heating installation after this.

- ▶ Arrange for the skilled tradesman to reset all settings to factory settings.

Menu → **Basic settings** → **Factory reset** → **Everything**

- While the controller is resetting the settings to the factory settings, **in process** is shown on the display. Then the installation assistant appears in the display, which only the skilled tradesman may operate.

5.2.20 Installer level

The Installer level is reserved for the skilled tradesman and is therefore protected by an access code. At this operating level, the skilled tradesman can make the necessary settings.

5.3 Operating modes

Use the right-hand selector button, **Operating mode** to set the mode directly.

If the heating installation is equipped with two heating circuits, the set operating mode only applies to the heating circuit preset by the skilled tradesman.

If you want to set different operating modes for two independent heating circuits, you can also set the operating mode using the left-hand selector button **Menu**. The **Operating mode** list entry in which the heating circuits are listed appears under **Basic settings**. In this case, you can set the operating mode separately for each heating circuit.

The path details given at the start of each mode description indicate how you can access this mode in the menu structure.

5.3.1 Operating modes for the heating circuit

5.3.1.1 Automatic mode

Operating mode → **Heating** → **Auto**

Menu → **Basic settings** → **Operating mode** → **HEATING 1** and, if relevant, **HEATING 2** → **Auto**

- The automatic mode controls the heating circuit in accordance with the set desired temperature and the set time periods.

Within the time periods, the controller brings the room temperature to the set desired **Day** temperature (Comfort mode).

Outside the time periods, the controller regulates in accordance with the mode set by the competent person.

Three modes are possible:

- **ECO** (factory setting): The heating function is switched off and the controller monitors the outside temperature. If the outside temperature falls below 3 °C, the controller switches the heating function on after the end of the frost protection delay time and brings the room temperature to the set desired **Set-back** (Set-back mode). Despite the heating function being activated, the burner is only active on demand. If the outside temperature rises above 4 °C, the controller switches the heating function off, but continues to monitor the outside temperature.
- **Frost protection**: The heating function is off and the frost protection function is active.
- **Set-back temperature**: The heating function is on and the controller brings the room temperature to the set desired **Set-back** (Set-back mode). When installing your controller, the competent person can specify the control functions for the times outside the periods and can specify the heating curve.

5.3.1.2 Comfort mode

Operating mode → **Heating** → **Day**

Menu → **Basic settings** → **Operating mode** → **HEATING 1** and, if relevant, **HEATING 2** → **Day**

- The **Day** operating mode brings the heating circuit to the desired **Day temperature** set, without taking time periods into account.

5.3.1.3 Set-back mode

Operating mode → **Heating** → **Set-back**

Menu → **Basic settings** → **Operating mode** → **HEATING 1** and, if relevant, **HEATING 2** → **Set-back**

- The **Set-back** operating mode brings the heating circuit to the desired **Set-back** temperature set, without taking time periods into consideration.

5.3.1.4 Summer mode

Operating mode → Heating → Summer

Menu → Basic settings → Operating mode → HEATING 1 and, if relevant, HEATING 2 → Summer

- The heating function is switched off for the heating circuit and the frost protection function is active.

5.3.2 Operating modes for ventilation

Applies to: Controller version VRC 470/4

If a ventilation unit is connected, you can set the operating modes directly using the right-hand selection button **Operating mode**.

The instructions for use for the ventilation unit explain how the ventilation unit works with the ventilation levels.

5.3.2.1 Automatic mode

Operating mode → Ventilation → Auto

- The automatic mode controls the ventilation in accordance with the ventilation level set and the set time periods.

Within the time periods, the controller regulates the exchange of air using the **Max. day ventilation level** ventilation level set (Comfort mode).

Outside the time periods, the controller regulates the exchange of air using the **Max. set-back ventilation level** ventilation level set (Night set-back mode).

5.3.2.2 Comfort mode

Operating mode → Ventilation → Day

- The **Day** operating mode regulates the exchange of air using the **Max. day ventilation level** ventilation level set, without taking time periods into account.

5.3.2.3 Set-back mode

Operating mode → Ventilation → Set-back

- The **Night set-back** operating mode regulates the exchange of air using the **Max. night set-back ventilation level**, without taking time periods into account.

5.3.3 Operating modes for hot water generation

5.3.3.1 Automatic mode

The automatic mode controls hot water generation in accordance with the set desired temperature for **Domestic hot water** and the set time periods.

Within the time period, hot water generation is switched on and maintains the hot water in the DHW cylinder at the pre-set temperature. Outside the time period, hot water generation is switched off.

5.3.3.2 Comfort mode

The comfort mode controls the hot water generation in accordance with the set desired temperature for **Hot water circuit** without taking time periods into account.

5.3.3.3 Set-back mode

Hot water generation is switched off and the frost protection function is activated.

5.3.4 Operating modes for circulation

The operating mode for the circulation always corresponds to the operating mode for the hot water generation. You cannot set a different operating mode.

5.3.4.1 Automatic mode

The automatic mode controls the circulation of the hot water in the hot water pipes in accordance with the set time periods. Within the time period, the circulation is switched on and outside the time period, the circulation is switched off.

5.3.4.2 Comfort mode

Circulation is activated and the time periods for circulation are not observed.

5.3.4.3 Set-back mode

The circulation is switched off and the Frost protection function is active.

5.3.5 Operating modes for cooling

Applies to: Controller version VRC 470/4

If a heat pump is connected and automatic cooling is activated, you can set the operating modes directly using the right-hand **Operating mode** selection button.

5 Operating and display functions

5.3.5.1 Automatic mode

Operating mode → Cooling → Auto

- The automatic mode controls the heating circuit in accordance with the set desired temperature and the set time periods.

Within the time periods, the controller brings the room temperature to the desired **Day cooling** temperature set (comfort mode).

Outside the time period, the cooling function is switched off.

5.3.5.2 Comfort mode

Operating mode → Cooling → Day

- The **Day** operating mode brings the heating circuit to the desired **Day cooling** temperature set, without taking time periods into account.

5.3.5.3 Off

The cooling function is switched off.

5.4 Advanced functions

The advanced functions can be activated directly from any mode using the right-hand selector button **Operating mode**.

If the heating installation is equipped with two heating circuits, the active advanced function only applies to the heating circuit preset by the skilled tradesman.

If the heating installation is equipped with two heating circuits and both circuits are active, you can also activate an advanced function using the left-hand selector button **Menu**. The **Operating mode** list entry in which the heating circuits are listed appears under **Basic settings**. In this case, you can set the advanced function separately for each heating circuit.

The path details given at the start of each advanced function description indicate how you can access this advanced function in the menu structure.

5.4.1 Manual cooling

Operating mode → Manual cooling

- If the outside temperature is high, you can activate the **Manual cooling** advanced function. You define for how many days you want to activate the advanced function. If you activate **Manual cooling**, you cannot use the heating function at the same time. The **Manual cooling** function takes priority over heating.

The setting applies for as long as the advanced function is active. The advanced function is deactivated if the days that are set have elapsed or if the outside temperature falls below 4 °C.

If a **VR 61/4** mixer module is connected, the **Desired temperatures** display also shows the **HEATING 2** list entry.

If you want to set the temperature separately for each of the heating circuits, you can set these temperatures using the **Desired temperatures** function.

5.4.2 1 day at home

Operating mode → 1 day at home

Menu → **Basic settings** → **Operating mode** → **HEATING 1** and, where required, **HEATING 2** → **1 day at home**

- If you are spending a weekday at home, activate the **1 day at home** advanced function. This advanced function activates **Automatic mode** for one day with the settings for **Sunday**, as set using the **Time programmes** function.

The advanced function is automatically deactivated after 00:00 (midnight) or if you cancel the advanced function first. The heating installation will then return to the pre-set mode.

5.4.3 1 day away from home

Operating mode → 1 Day away from home

Menu → **Basic settings** → **Operating mode** → **HEATING 1** and, where required, **HEATING 2** → **1 Day away from home**

- If you are only away from home for one day, activate the **1 day away from home** advanced function. This advanced function brings the room temperature to the desired **Set-back** temperature.

Hot water generation and circulation are switched off and the frost protection is activated.

The advanced function is automatically deactivated after 00:00 (midnight) or if you cancel the advanced function first. The heating installation will then return to the pre-set mode.

Applies to: Controller version VRC 470/4

Ventilation is activated and works at the lowest ventilation level.

5.4.4 Ventilation boost

Operating mode → Ventilation boost

Menu → **Basic settings** → **Operating mode** → **HEATING 1** and, where required, **HEATING 2** → **Ventilation boost**

- If you want to switch the heating circuit off while the living rooms are being ventilated, activate the **Ventilation boost** advanced function.

This advanced function switches the heating circuit off for 30 minutes. The Frost protection function is activated, the ventilation unit works at the highest ventilation level, and hot water generation and circulation remain active. The advanced function is automatically deactivated after 30 minutes or if you cancel the advanced function early. The heating installation will then return to the pre-set mode.

5.4.5 Party function

Operating mode → Party function

Menu → **Basic settings** → **Operating mode** → **HEATING 1** and, where required, **HEATING 2** → **Party function**

- If you want to switch on the heating circuit, hot water generation, ventilation and circulation temporarily, activate the **Party function** advanced function.

The advanced function brings the room temperature to the set desired **Day** temperature, in accordance with the set time periods.

The advanced function is deactivated when the next time period is reached or if you cancel the advanced function early. The heating installation will then return to the pre-set mode.

5.4.6 Cylinder boost

Operating mode → Cylinder boost

- If you have switched off hot water generation or require hot water outside a time period, then activate the **Cylinder boost** advanced function.

The advanced function heats the water in the domestic hot water cylinder once until the desired **Domestic hot water** temperature set is reached or until you cancel the advanced function early. The heating installation will then return to the pre-set mode.

5.4.7 System OFF (Frost protection active)

Operating mode → System OFF

- The heating function, hot water circuit and cooling are switched off. The frost protection function is activated.

The circulation is switched off.

Applies to: Controller version VRC 470/4

Ventilation is activated and works at the lowest ventilation level.

5.5 Messages

5.5.1 Service message

If a service is required, the controller displays a service message in the display.

To prevent the heating installation from breaking down and to prevent damage, you must pay attention to the service message:

- ▶ If the instructions for use for the unit that is displayed contain maintenance instructions for the service message, carry out maintenance work according to the maintenance instructions.
- ▶ If the instructions for use for the unit displayed do not contain maintenance instructions for the service message, or if you do not want to carry out the maintenance work yourself, inform a competent person.

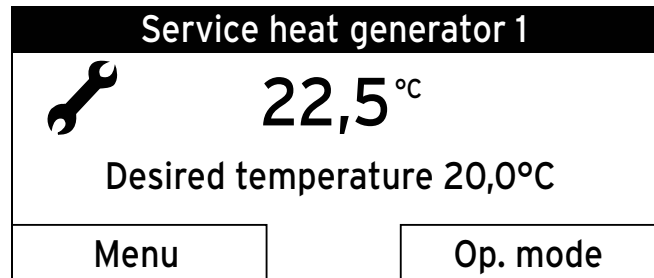

The following service messages may appear:

- **Service heat generator 1** (boiler, heat pump)
- **Service heat generator 2** (boiler, heat pump)
- **Service** (of the heating installation)
- **Water deficiency heat generator 1** (boiler, heat pump)
- **Water deficiency heat generator 2** (boiler, heat pump)
- **Low water pressure add-on module** (monoblock heat pump)
- **Ventilation unit service** (on VRC 470/4)

5.5.2 Fault message

If a fault occurs in the heating installation, then the fault message indicates that a competent person must perform troubleshooting or repair the heating installation.

Failure to take notice of these fault messages may lead to material damage or a breakdown of the heating system.

- ▶ Inform a competent person.

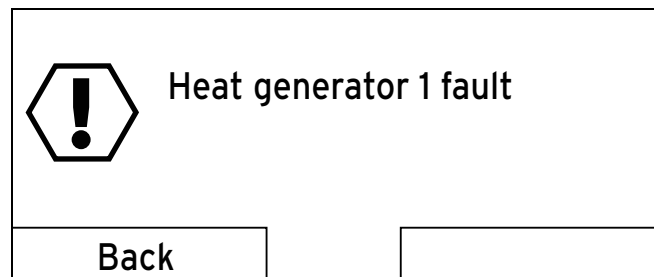

If the controller shows a fault message in the display instead of the basic display and you press the left-hand function key **Back**, then the basic display appears again.

You can also read current fault messages under **Menu** → **Information** → **System status** → **Status**. As soon as a fault message for the heating installation appears, the **Status** setting level displays **Fault**. In this case, the right-hand function key has the function **Display**.

6 Service and troubleshooting

6 Service and troubleshooting

6.1 Cleaning the controller

1. Clean the casing of the controller with a damp cloth.
2. Never use scouring or cleaning agents which could damage the operator control elements or the display.

6.2 Detecting and rectifying faults

Fault	Cause	Troubleshooting
Display is dark	Appliance fault	<ul style="list-style-type: none"> – Switch off the mains switch on all heat generators for approx. 1 minute and then switch them on again – If the fault is still present, inform the competent person
No changes in the display via the rotary knob		
No changes in the display via the selection buttons		

7 Decommissioning

7.1 Replacing the controller

If the controller of the heating system needs to be replaced, the heating system must be shut down.

- ▶ This work should be carried out by a competent person.

7.2 Recycling and disposal

The controller and the associated transport packaging consist largely of recyclable materials.

Unit



If the product is identified with this symbol, it does not belong with the household waste at the end of its useful life.

- ▶ Instead, take the product to a collection point for recycling electrical and electronic devices.

For more information on where to take used electrical or electronic devices, contact the town or district authorities, waste disposal company, or the competent person who installed the product.

Disposing of the packaging

- ▶ The competent person who installed the product is responsible for disposing of the packaging.

8 Guarantee and customer service

8.1 Guarantee

We only grant a Vaillant manufacturers warranty if a suitably qualified engineer has installed the system in accordance with Vaillant instructions. The system owner will be granted a warranty in accordance with the Vaillant terms and conditions. All requests for work during the guarantee period must be made to Vaillant Service Solutions (0870 6060 777).

8.2 Customer service

To ensure regular servicing, it is strongly recommended that arrangements are made for a Maintenance Agreement. Please contact Vaillant Service Solutions (0870 6060 777) for further details.

9 Technical data

9.1 Controller

Designation	Value
Operating voltage U _{max}	24 V
Current consumption	< 50 mA
Supply line cross-section	0.75 ... 1.5 mm ²
Level of protection	IP 20
Protection class	III
Maximum permissible ambient temperature	50 °C
Height	115 mm
Width	147 mm
Depth	50 mm

9.2 Sensor resistances

Temperature (°C)	Resistance (ohms)
-25	2167
-20	2067
-15	1976
-10	1862
-5	1745
0	1619
5	1494
10	1387
15	1246
20	1128
25	1020
30	920
35	831
40	740

Appendix

A Operating modes

Operating mode	Setting	Factory reset	Own setting
Operating mode			
Heating	Auto	Auto	
	Day	Not active	
	Set-back	Not active	
	Summer	Not active	
Cooling	Auto	Not active	
	Day	Not active	
	Off	Off	
Ventilation	Auto	Auto	
	Day	Not active	
	Set-back	Not active	
Domestic hot water	Auto	Auto	
	Day	Not active	
	Off	Not active	
Advanced functions			
Manual cooling	Active, Not active	Not active	
1 day at home	Active, Not active	Not active	
1 day away from home	Active, Not active	Not active	
1 x ventilation boost	Active, Not active	Not active	
Party function	Active, Not active	Not active	
Cylinder boost	Active, Not active	Not active	
System OFF (Frost protection active)	Active, Not active	Not active	

B Overview of operating levels

Setting level	Values		Unit	Increment/Select	Factory reset	Setting
	Min.	Max.				
Information → System status →						
System						
Status	Current value					
Water pressure	Current value		bar			
Domestic hot water	Current value			Charged, Charging		
Collector temperature ^{1) or 6)}	Current value		°C			
Solar yield ^{1) or 6)}	Current value		kWh			
Reset solar yield ¹⁾	Current value			Yes, No	No	
Environment yield ⁵⁾	Current value		kWh			
Reset environment yield ⁵⁾	Current value			Yes, No	No	
1) Appears only if the VR 68/2 solar module is connected. 2) Appears only if the VR 61/4 mixer module is connected. 3) Appears only if the VR 81/2 remote control unit is connected. 4) This value depends on the expansion module connected. If no expansion module is connected, the upper limit may be limited by the setting on the boiler. 5) Appears only if a heat pump is connected. 6) Appears only if the VMS solar pump unit is connected. 7) Appears only if the recoVAIR.../4 ventilation unit is connected and the VRC 470/4 controller is used. 8) Appears only if a hybrid heat pump is connected.						

Appendix

Setting level	Values		Unit	Increment/Select	Factory reset	Setting
	Min.	Max.				
Electrical consumption ⁵⁾	Current value		kWh			
Reset electrical consumption ⁵⁾	Current value			Yes, No	No	
Current room air humidity	Current value		%rel			
Current dew point	Current value		°C			
triVAI ⁸⁾	Current value					
HEATING 1 and, if relevant, HEATING 2 ²⁾ →						
Day temp. heating	Current value		°C	0.5	20	
	5	30				
Day temp. cooling ⁵⁾	Current value		°C	0.5	26	
	15	30				
Night temp. heating	Current value		°C	0.5	15	
	5	30				
Room temperature ³⁾	Current value		°C			
Auto day temp until	Current value		h:min			
away from	Current value		dd.mm.yy			
away to	Current value		dd.mm.yy			
At home from	Current value		dd.mm.yy			
At home to	Current value		dd.mm.yy			
Ventilation ⁷⁾ →						
Air quality sensor 1	Current value		ppm			
Air quality sensor 2	Current value		ppm			
Air quality sensor 3	Current value		ppm			
Exhaust air humidity	Current value		%rel			
Information → Solar yield ¹⁾ →						
Bar chart	Previous year to current year comparison		kWh/month			
Information → Environment yield ⁵⁾ →						
Bar chart	Previous year to current year comparison		kWh/month			
Information → Electrical consumption ⁵⁾ →						
Bar chart	Previous year to current year comparison		kWh/month			
Information → Contact details →						
Installer Phone	Current values					
<p>1) Appears only if the VR 68/2 solar module is connected.</p> <p>2) Appears only if the VR 61/4 mixer module is connected.</p> <p>3) Appears only if the VR 81/2 remote control unit is connected.</p> <p>4) This value depends on the expansion module connected. If no expansion module is connected, the upper limit may be limited by the setting on the boiler.</p> <p>5) Appears only if a heat pump is connected.</p> <p>6) Appears only if the VMS solar pump unit is connected.</p> <p>7) Appears only if the recoVAIR.../4 ventilation unit is connected and the VRC 470/4 controller is used.</p> <p>8) Appears only if a hybrid heat pump is connected.</p>						

Setting level	Values		Unit	Increment/Select	Factory reset	Setting
	Min.	Max.				
Information → Serial number						
Appliance number	Permanent value					
Desired temperatures → HEATING 1 and, if relevant, HEATING 2²⁾ →						
Day	5	30	°C	0.5	20	
Day cooling ⁵⁾	15	30	°C	0.5	26	
Set-back	5	30	°C	0.5	15	
Desired temperatures → Domestic hot water →						
Domestic hot water	35	70	°C	1	60	
Ventilation level⁷⁾ →						
Max. day ventilation level	1	10		1	7	
Max. set-back ventilation level	1	10		1	3	
Time programmes → HEATING 1 and, if relevant, HEATING 2²⁾ →						
Individual days and blocks				Mo, Tu, We, Th, Fr, Sa, Su and Mo - Fr, Sa - Su, Mo - Su	Mo - Fr: 06:00-22:00 Sa: 07:30-23:30 Su: 07:30-22:00	
Time period 1: Start - End	00:00	24:00	h:min	10 min		
Time period 2: Start - End						
Time period 3: Start - End						
Time programmes → Heating circuit 1 cooling periods and, if relevant, Heating circuit 2 cooling periods^{2) 5)} →						
Individual days and blocks				Mo, Tu, We, Th, Fr, Sa, Su and Mo - Fr, Sa - Su, Mo - Su	Mo - Su: 00:00-24:00	
Time period 1: Start - End	00:00	24:00	h:min	10 min		
Time period 2: Start - End						
Time period 3: Start - End						
Time programmes → Domestic hot water → Preparation →						
Individual days and blocks				Mo, Tu, We, Th, Fr, Sa, Su and Mo - Fr, Sa - Su, Mo - Su	Mo - Fr: 06:00-22:00 Sa: 07:30-23:30 Su: 07:30-22:00	
Time period 1: Start - End	00:00	24:00	h:min	10 min		
Time period 2: Start - End						
Time period 3: Start - End						
Time programmes → Domestic hot water → Circulation →						
<p>1) Appears only if the VR 68/2 solar module is connected.</p> <p>2) Appears only if the VR 61/4 mixer module is connected.</p> <p>3) Appears only if the VR 81/2 remote control unit is connected.</p> <p>4) This value depends on the expansion module connected. If no expansion module is connected, the upper limit may be limited by the setting on the boiler.</p> <p>5) Appears only if a heat pump is connected.</p> <p>6) Appears only if the VMS solar pump unit is connected.</p> <p>7) Appears only if the recoVAIR.../4 ventilation unit is connected and the VRC 470/4 controller is used.</p> <p>8) Appears only if a hybrid heat pump is connected.</p>						

Appendix

Setting level	Values		Unit	Increment/Select	Factory reset	Setting
	Min.	Max.				
Individual days and blocks				Mo, Tu, We, Th, Fr, Sa, Su and Mo - Fr, Sa - Su, Mo - Su	Mo - Fr: 06:00- 22:00 Sa: 07:30-23:30 Su: 07:30-22:00	
Time period 1: Start - End	00:00	24:00	h:min	10 min		
Time period 2: Start - End						
Time period 3: Start - End						
Time programmes → Tariff periods ⁵⁾ →						
Individual days and blocks				Mo, Tu, We, Th, Fr, Sa, Su and Mo - Fr, Sa - Su, Mo - Su	Mo - Su: 11:00- 13:00	
Time period 1: Start - End	00:00	24:00	h:min	10 min		
Time period 2: Start - End						
Time period 3: Start - End						
Time programmes → Noise reduction periods ⁵⁾ →						
Individual days and blocks				Mo, Tu, We, Th, Fr, Sa, Su and Mo - Fr, Sa - Su, Mo - Su		
Time period 1: Start - End	00:00	24:00	h:min	10 min		
Time period 2: Start - End						
Time period 3: Start - End						
Time programmes → Ventilation ⁷⁾ →						
Individual days and blocks				Mo, Tu, We, Th, Fr, Sa, Su and Mo - Fr, Sa - Su, Mo - Su		
Time period 1: Start - End	00:00	24:00	h:min	10 min		
Time period 2: Start - End						
Time period 3: Start - End						
Days away from home scheduling → HEATING 1 and, if relevant, HEATING 2 ²⁾ →						
Start	01.01.00	31.12.99	dd.mm.yy	Day.Month.Year	01.01.10	
End	01.01.00	31.12.99	dd.mm.yy	Day.Month.Year	01.01.10	
Temperature	Frost protection or 5	30	°C	0.5	10	
Days at home scheduling → HEATING 1 and, if relevant, HEATING 2 ²⁾ →						
Start	01.01.00	31.12.99	dd.mm.yy	Day.Month.Year	01.01.10	
End	01.01.00	31.12.99	dd.mm.yy	Day.Month.Year	01.01.10	
Basic settings → Language →						
				Selectable language	English	
<p>1) Appears only if the VR 68/2 solar module is connected.</p> <p>2) Appears only if the VR 61/4 mixer module is connected.</p> <p>3) Appears only if the VR 81/2 remote control unit is connected.</p> <p>4) This value depends on the expansion module connected. If no expansion module is connected, the upper limit may be limited by the setting on the boiler.</p> <p>5) Appears only if a heat pump is connected.</p> <p>6) Appears only if the VMS solar pump unit is connected.</p> <p>7) Appears only if the recoVAIR.../4 ventilation unit is connected and the VRC 470/4 controller is used.</p> <p>8) Appears only if a hybrid heat pump is connected.</p>						

Setting level	Values		Unit	Increment/Select	Factory reset	Setting
	Min.	Max.				
Basic settings → Date/Time →						
Date	01.01.00	31.12.99	dd.mm.yy	Day.Month.Year	01.01.10	
Time	00:00	24:00	h:min	10 min	00:00	
Daylight saving				Off, Auto	Off	
Basic settings → Display →						
Display contrast	01	15		1	9	
Preferred display ^{5) or 7)}				Heating, cooling, ventilation	Heating	
Basic settings → Offset →						
Room temperature	-3.0	3.0	K	0.5	0.0	
Outside temperature	-3.0	3.0	K	0.5	0.0	
Cooling ⁵⁾	-5.0	20.0	°C	1	15	
Basic settings → Costs ⁵⁾ →						
Auxiliary boiler (gas, oil, electricity) ⁵⁾	0	999		1	12	
Low electricity tariff (heat pump) ⁵⁾	0	999		1	16	
High electricity tariff (heat pump) ⁵⁾	0	999		1	20	
Basic settings → Ventilation ⁷⁾ →						
Heat recovery				Auto, activate	Auto	
Basic settings → Room air humidity →						
Max. room air humidity	30	70	%rel	1	40	
Basic settings → Operating mode ²⁾ → HEATING 1 and, if relevant, HEATING 2 ²⁾ →						
Heating				Auto, Day, Set-back, Summer	Auto	
Cooling				Off, Auto, Day	Off	
1 day at home				Active, Not active	Not active	
1 day away from home				Active, Not active	Not active	
1 x ventilation boost				Active, Not active	Not active	
Party function				Active, Not active	Not active	
Basic settings → Change heating circuit naming →						
<p>1) Appears only if the VR 68/2 solar module is connected.</p> <p>2) Appears only if the VR 61/4 mixer module is connected.</p> <p>3) Appears only if the VR 81/2 remote control unit is connected.</p> <p>4) This value depends on the expansion module connected. If no expansion module is connected, the upper limit may be limited by the setting on the boiler.</p> <p>5) Appears only if a heat pump is connected.</p> <p>6) Appears only if the VMS solar pump unit is connected.</p> <p>7) Appears only if the recoVAIR.../4 ventilation unit is connected and the VRC 470/4 controller is used.</p> <p>8) Appears only if a hybrid heat pump is connected.</p>						

Appendix

Setting level	Values		Unit	Increment/Select	Factory reset	Setting
	Min.	Max.				
HEATING 1	1	10	Letter/number	A to Z, 0 to 9, space	HEATING 1	
HEATING 2 ²⁾	1	10	Letter/number	A to Z, 0 to 9, space	HEATING 2	
Basic settings → Factory reset (reset) →						
Time programmes				Yes, No	No	
Everything				Yes, No	No	
Installer level →						
Enter code	000	999		1	000	
<p>1) Appears only if the VR 68/2 solar module is connected.</p> <p>2) Appears only if the VR 61/4 mixer module is connected.</p> <p>3) Appears only if the VR 81/2 remote control unit is connected.</p> <p>4) This value depends on the expansion module connected. If no expansion module is connected, the upper limit may be limited by the setting on the boiler.</p> <p>5) Appears only if a heat pump is connected.</p> <p>6) Appears only if the VMS solar pump unit is connected.</p> <p>7) Appears only if the recoVAIR.../4 ventilation unit is connected and the VRC 470/4 controller is used.</p> <p>8) Appears only if a hybrid heat pump is connected.</p>						

Index

A		
Access level		
Operator.....	8	
Skilled tradesman	8	
Advanced functions	20	
1 day at home	20	
1 day away from home	20	
Cooling.....	20	
Cylinder boost.....	21	
Party function.....	20	
Ventilation boost	20	
Air humidity		
Reading	12	
Applicability		
Instructions	4	
Article number		
Reading	12	
Automatic mode	18–20	
B		
Basic display	8	
Block		
Deviating times	14	
C		
CE label	6	
Circulation	8	
Cleaning		
Controller	22	
Comfort mode.....	18–20	
Contact details		
Skilled tradesman	12	
Control function	7	
Controller		
Cleaning.....	22	
Cooling offset		
Setting.....	17	
Costs		
Setting.....	17	
D		
Date		
Changing	10	
Setting.....	16	
Daylight saving time		
Changing to	16	
Days at home		
Scheduling.....	16	
Days away from home		
Scheduling.....	15	
Design		
Unit	7	
Desired day temperature		
Changing	10	
Desired setting	9	
Desired temperatures		
Heating circuit.....	13	
Hot water generation	13	
Setting.....	13	
Dew point		
Reading	12	
Display		
Article number.....	7, 12	
Environmental statistics.....	12	
List of status messages	11	
Power statistics.....	12	
Serial number	7, 12	
Skilled tradesman contact details	12	
Solar statistics.....	12	
System status	11	
Time programmes.....	14–15	
Display contrast		
set	16	
Documents		
Other applicable.....	4	
E		
Electrical consumption		
Reading	12	
Resetting.....	12	
Environment yield		
Reading	12	
Resetting.....	12	
Environmental statistics		
Reading	12	
F		
Factory setting		
Resetting to.....	18	
Fault message.....	21	
Faults		
Detecting.....	22	
Rectifying.....	22	
Frost damage		
Switching off	5	
Temperature	6	
Frost protection function.....	8	
Cooling.....	8	
H		
Heat recovery		
Activating	17	
Heating circuit		
Desired temperatures	13	
Heating circuit names		
enter.....	17	
Heating installation	7	
Cooling.....	7	
Hybrid manager	7	
Ventilation	7	
High electricity tariff		
Setting.....	17	
Hot water generation	8	
Desired temperatures	13	
I		
Installation		
only by a skilled tradesman	5	
Installer level	18	
Intended use.....	6	
L		
Language		
Selecting	16	
Setting.....	16	
Legionella		
Drinking water.....	5	

Index

List entries		Scheduling	
Heat pump	12	Days at home.....	16
List of status messages		Days away from home.....	15
Reading	11	Selection level	9
Low electricity tariff		Sensor resistances.....	22
Setting.....	17	Serial number	
M		Reading	12
Malfunction		Serial number and article number	
Preventing.....	5	Reading	12
Mode		Service message.....	21
Automatic mode.....	18	Set-back mode	18–19
N		Setting	
Nomenclature	4	Date	16
O		Offset outside temperature	17
Offset outside temperature		Offset room temperature	16
Setting.....	17	Room air humidity.....	17
Offset room temperature		Time.....	16
Setting.....	16	Time periods for days and blocks.....	14
Operating and display functions	11	Setting level.....	9
Operating concept.....	9	Skilled tradesman	
Operating example	10	Contact details	12
Operating level	8	Soft key function	9
Operating levels		Solar statistics	
Overview.....	11	Displaying	12
Operating mode		Reading	12
Automatic mode.....	19–20	Standard time	
Cooling:.....	19–20	Changing to	16
Ventilation	19	Status messages.....	11
Operating modes.....	9, 18, 23	Summer mode.....	19
Circulation.....	19	Symbols.....	9
Operating modes for circulation		System OFF	21
Automatic mode.....	19	System status	
Comfort mode.....	19	Reading	11
Set-back mode.....	19	T	
Operating modes for hot water generation		Tariff for auxiliary boiler	
Automatic mode.....	19	Setting.....	17
Comfort mode.....	19	Time	
Set-back mode.....	19	Setting.....	16
Outside temperature		Time periods for days and blocks.....	14
Set offset.....	17	Time programmes	
P		Cooling.....	14
Power statistics		Noise reduction periods.....	15
Reading	12	quick setting.....	14
Preferred display		Setting.....	13
Setting.....	16	Tariff periods.....	15
R		Ventilation	15
Reading		triVAI	
Air humidity	12	Reading	12
Dew point.....	12	V	
Environment yield	12	Ventilation level	
triVAI	12	Setting.....	13
Resetting			
To factory setting	18		
Room air humidity			
Setting.....	17		
Room temperature			
Setting the offset.....	16		
S			
Scalding			
Drinking water.....	5		

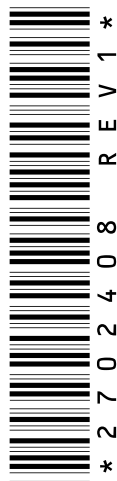

0020116689_01

Vaillant Ltd

Nottingham Road ■ Belper ■ Derbyshire ■ DE56 1JT
Telephone +44 845 602 29 22 ■ Vaillant Service Solutions +44 80 70 606 07 77
info@vaillant.co.uk ■ www.vaillant.co.uk